



Freezer Service and Maintenance Manual

i.Series® and Horizon Series™

Laboratory

i.Series

iLF120-GX

iLF125-GX

Horizon Series

HLF120-GX

HLF125-GX

Plasma Storage

i.Series

iBF120-GX

iBF125-GX

Horizon Series

HBF120-GX

HBF125-GX



Document History

Revision	Date	CO	Supersession	Revision Description
A	8 APR 2021	15919	n/a	Initial release.
B	17 AUG 2021	16176	B supersedes A	<ul style="list-style-type: none">• Added GFI/GFCI note to Placement and Leveling sections.• Updated Refrigerant Charge table.• Updated Remove/Install shelf instructions.• Updated references to 9V Lithium back-up battery in Horizon Section.
C	19 DEC 2022	17147	C supersedes B	<ul style="list-style-type: none">• Updated part numbers for evaporator fan motor and evaporator fan blade in both i.Series and Horizon Series Parts sections.• Updated voltage information in External Monitoring Devices section.• Updated Alarm Indications table to include alternate visual indicator for No Battery alarm.
D	03 NOV 2023	26755	D supersedes C	<ul style="list-style-type: none">• Updated i.Series and Horizon parts tables to reflect multiple part number changes and additions.

* Date submitted for Change Order review. Actual release date may vary.

Document Updates

The document is furnished for information use only, is subject to change without notice and should not be construed as a commitment by Helmer Scientific. Helmer Scientific assumes no responsibility or liability for any errors or inaccuracies that may appear in the informational content contained in this material. For the purpose of clarity, Helmer Scientific considers only the most recent revision of this document to be valid.

Notices and Disclaimers

Confidential / Proprietary Notices

Use of any portion(s) of this document to copy, translate, disassemble or decompile, or create or attempt to create by reverse engineering or otherwise replicate the information from Helmer Scientific products is expressly prohibited.

Copyright and Trademark

Copyright © 2023 Helmer, Inc. Helmer®, i.Series®, i.C³®, Horizon Series™, and Rel.i™ are registered trademarks or trademarks of Helmer, Inc. in the United States of America. All other trademarks and registered trademarks are the property of their respective owners. Helmer, Inc., doing business as (DBA) Helmer Scientific and Helmer.

Disclaimer

This manual is intended as a guide to provide the operator with necessary instructions on the proper use and maintenance of certain Helmer Scientific products.

Any failure to follow the instructions as described could result in impaired product function, injury to the operator or others, or void applicable product warranties. Helmer Scientific accepts no responsibility for liability resulting from improper use or maintenance of its products.

The screenshots and component images appearing in this guide are provided for illustrative purposes only, and may vary slightly from the actual software screens and/or product components.

Contents

- 1 About This Manual 4**
 - 1.1 Intended Audience 4
 - 1.2 Model Reference 4
 - 1.3 Intended Use 4
 - 1.4 Safety Symbols and Precautions 4
 - 1.5 Avoiding Injury 5
 - 1.6 Model and Input Power 5
 - 1.7 Product Labels 6
- i.Series Information 7**
- 2 Installation and Configuration 7**
 - 2.1 Location Requirements 7
 - 2.2 Placement and Leveling 7
 - 2.3 Connect Back-Up Power 7
 - 2.4 Prepare for Monitoring 8
 - 2.5 Configure Storage 11
- 3 Controls 13**
 - 3.1 Home Screen and Screensaver 13
 - 3.2 Home Screen Functions 13
 - 3.3 Alarm Reference 13
 - 3.4 Settings 14
 - 3.5 Sensor Calibration 18
- 4 Maintenance 22**
 - 4.1 Alarm Tests 23
 - 4.2 Test and Replace Back-up Batteries 25
 - 4.3 Check Probe Bottle(s) 26
 - 4.4 Display Board Battery 26
 - 4.5 Upgrade System Firmware 26
 - 4.6 Clean the Freezer 26
- 5 Service 28**
 - 5.1 Refrigerant 28
 - 5.2 Remove/Replace Unit Cooler Cover 28
- 6 Troubleshooting 30**
 - 6.1 Access System Problems 30
 - 6.2 Alarm Activation Problems 30
 - 6.3 Chamber Temperature Problems 31
 - 6.4 Condensation and Icing Problems 31
- 7 i.Series Parts 32**
- 8 Schematics 35**
 - 8.1 iBF and iLF Models 35

Horizon Series Information. 37

9 Installation and Configuration 37

9.1 Location Requirements 37

9.2 Placement and Leveling 37

9.3 Connect Back-Up Power 37

9.4 Defrost Events 38

9.5 Prepare for Monitoring 39

9.6 Configure Storage 41

10 Controls. 43

10.1 Monitor and Control Interface 43

10.2 Alarm Reference 45

10.3 Settings 46

11 Maintenance 49

11.1 Alarm Tests 50

11.2 Test and Replace Back-up Batteries 51

11.3 Check Probe Bottle 52

11.4 Clean the Freezer 52

12 Service. 53

12.1 Refrigerant 53

12.2 Remove / Replace Unit Cooler Cover 53

13 Troubleshooting 55

13.1 Access System Problems 55

13.2 Alarm Activation Problems. 55

13.3 Chamber Temperature Problems 56

13.4 Condensation and Icing Problems. 56

14 Horizon Series Parts 57

15.1 HBF and HLF Models 60

15.2 HBF and HLF Models (without Access Control) 61

15.3 HBF and HLF Models (with Access Control) 62

Appendix A: Warranty 63

1 About This Manual

1.1 Intended Audience

This manual provides information on how to use i.Series® and Horizon Series™ laboratory, and plasma storage freezers. It is intended for use by end users of the freezer and authorized service technicians.

1.2 Model Reference

Models are indicated by a distinguishing model number that corresponds to the series, type, number of doors, and capacity of the freezer. For example, “iLF125-GX” refers to an i.Series Laboratory Freezer with 1 door and a capacity of 25 cu ft, while “HLF120-GX” refers to a Horizon Series Laboratory Freezer with 1 door and a capacity of 20 cu ft..

1.3 Intended Use

Note

This equipment has been tested and found to comply with the limits for a Class A digital device, pursuant to part 15 of the FCC Rules. These limits are designed to provide reasonable protection against harmful interference when the equipment is operated in a commercial environment. This equipment generates, uses and can radiate radio frequency energy and, if not installed and used in accordance with the instruction manual, may cause harmful interference to radio communications. Operation of this equipment in a residential area is likely to cause harmful interference in which case the user will be required to correct the interference at his own expense.

Helmer freezers are intended for the storage of blood products and other medical and scientific products.

1.4 Safety Symbols and Precautions

Symbols found in this document

The following symbols are used in this manual to emphasize certain details for the user:



Task Indicates procedures which need to be followed.



Note Provides useful information regarding a procedure or operating technique when using Helmer Scientific products.

NOTICE Advises the user against initiating an action or creating a situation which could result in damage to equipment; person injury is unlikely.

Symbols and Labels found on the units

The following symbols may be found on the freezer or freezer packaging:



Warning: Consult manual for important cautionary information



Warning: Crushing of hands / fingers



Warning: Hot surface



Danger: Risk of Fire or Explosion. Flammable refrigerant used



Warning: Shock / electrical hazard



Refer to documentation

1.5 Avoiding Injury



- Do not use mechanical devices or other means to accelerate the defrosting process, other than those recommended by the manufacturer.
- Do not damage the refrigerant circuit.

Review safety instructions before installing, using, or maintaining the equipment.

- ◆ Before moving unit, ensure the door is closed and casters are unlocked and free of debris.
- ◆ Before moving unit, disconnect the AC power cord and secure the cord.
- ◆ Never physically restrict any moving component.
- ◆ Avoid removing electrical service panels and access panels unless so instructed.
- ◆ Keep hands away from pinch points when closing the door.
- ◆ Avoid sharp edges when working inside the electrical compartment and refrigeration compartment.
- ◆ Ensure products are stored at recommended temperatures determined by standards, literature, or good laboratory practices.
- ◆ Proceed with caution when adding and removing product from the freezer.
- ◆ Do not open multiple loaded drawers at the same time.
- ◆ Use only a manufacturer supplied power cord.
- ◆ Avoid risk of ignition by using only manufacturer supplied components and authorized personnel when servicing the unit.
- ◆ Using the equipment in a manner not specified by the manufacturer may impair the protection provided by the equipment.
- ◆ Ensure product is stored safely, in accordance with all applicable organizational, regulatory, and legal requirements.
- ◆ The freezer is not considered to be a storage cabinet for flammable or hazardous materials.

REQUIRED: Decontaminate parts prior to sending for service or repair. Contact Helmer or your distributor for decontamination instructions and a Return Authorization Number.

1.6 Model and Input Power



Service information varies depending on the model and power requirements.

Table 1. Model and Input Power

Model	Voltage	Frequency	Current Draw
120	115V	60 Hz	6.6A
	220-240V	50/60 Hz	3.1A
125	115V	60 Hz	6.6A
	220-240V	50/60 Hz	3.1A

* Amperage values are subject to change. Refer to the product specification label on your unit for current values.

1.7 Product Labels

This information appears on the product specification label, located on the rear of the freezer below the electrical panel. The model also appears on a label located in the chamber on the upper right-side wall.

Note

Information contained in this specification label varies depending on the model and power requirements.

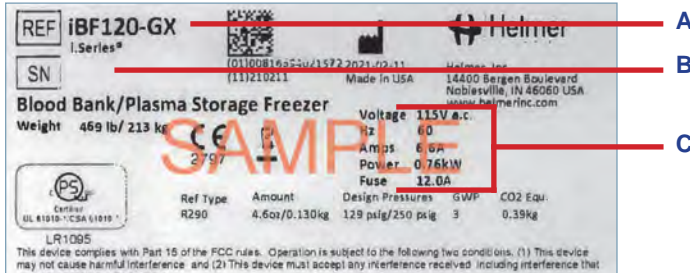

Label	Description
A	Model (REF)
B	Serial number
C	Power requirements

Sample Product Specification label.
 (For illustration only: regulatory information and other content shown here may differ from that on the equipment label)

i.Series Information

2 Installation and Configuration

2.1 Location Requirements



Keep all ventilation openings in the enclosure or, in the structure for building-in, clear of obstruction.

- ◆ Has a grounded outlet meeting the electrical requirements listed on the product specification label.
- ◆ Is clear of direct sunlight, high temperature sources, heating vents, and air conditioning vents.
- ◆ Has a minimum of 8" (203 mm) above, and a minimum of 3" (76 mm) behind the unit for proper ventilation, clearance, and feature access.
- ◆ Meets specified limits for ambient temperature and relative humidity as stated in the Product Specifications section of the Instructions for Use manual.

2.2 Placement and Leveling

NOTICE

- Helmer does not recommend operating this unit on a GFI/GFCI outlet.
- To prevent tipping, ensure the casters are unlocked and the door is closed before moving the freezer.
- To avoid damaging refrigerant tubing or risking refrigerant leak, use caution when moving or operating the unit.
- Use of leveling legs or casters is required.

1. Ensure the door is secured and casters are unlocked.
2. Move the freezer into place. Lock the casters.
3. Ensure the freezer is level.

2.3 Connect Back-Up Power

The monitoring system and chart recorder each have a back-up battery system enabling a period of continuous operation if power is lost.

Battery life varies by manufacturer, voltage level remaining as well as whether optional Access Control is installed. Providing the battery switch is full power is available, Access Control is not installed, and no battery-related alarms are active, back-up power for the monitoring system is available for up to 20 hours (the Low Battery alarm will activate after approximately 18 hours of battery use). Providing full power is available, back-up power for the monitoring system and optional Access Control system is available for up to 2.5 hours.



Before installing or replacing batteries, switch AC power and back-up battery switches OFF. Disconnect the freezer from AC power.

Notes

- The optional Access Control system uses the monitoring system back-up battery for back-up power in the event of power failure.
- The monitoring system will start on back-up battery power alone. If the freezer was not previously connected to AC power and the back-up battery is switched on, the monitoring system will begin running on back-up battery power.
- If AC power is lost, the monitoring system will automatically disable some features to prolong back-up battery power. Data collection will continue until back-up battery power is depleted.

The monitoring system back-up battery is located on top of the freezer. Turn the back-up battery switch ON to enable the back-up battery.



Monitoring system back-up battery.

2.4 Prepare for Monitoring

The back-up battery switch is switched OFF for shipping. Switch the back-up battery switch ON to provide the monitoring system and optional Access Control system with back-up power in the event of AC power failure.



Temperature Probes

i Notes

- Temperature probes are fragile; handle with care.
- Failure to fill the probe bottle or keep the probe bottle filled to the appropriate level may cause the chamber temperature to display higher or lower than the actual temperature.
- Remote probes may also be introduced through the existing port and immersed in the existing probe bottle.
- External probes should not be routed into the chamber through the door opening as this may cause issues with the door seal.
- i.Series models are equipped with a primary and secondary monitor probe. The secondary monitor probe is located in the lower left corner of the cabinet.

Probe bottle(s) and propylene glycol have been provided with this unit. The propylene glycol is mixed with water to create a solution which, when placed in the probe bottle, simulates the product stored in the freezer. The product simulation solution temperature reflects the product's temperature during normal operation.

The probe bottle should contain 4 oz. (120 mL) of product simulation solution (1:1 ratio of water to propylene glycol).



Probe bottle with probe.

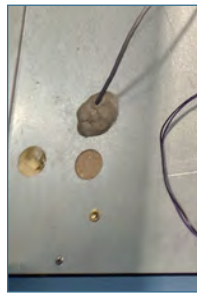

Top access port.

i Fill Probe Bottle

1. Remove the probe(s) from the bottle and remove the bottle from the bracket.
2. Remove the cap and fill with 4 oz. (120 mL) of product simulation solution.
3. Replace and secure the cap and place the bottle in the bracket.
4. Replace the probe(s), immersing at least 2" (50 mm) in solution.

i Install Additional Probe Through Top Port

1. Peel back putty to expose the port.
2. Insert the probe through the port into the chamber.
3. Insert the probe into the bottle.
4. Replace putty, ensuring a tight seal.

Chart Recorder (if included)

Note

- If the chart recorder has been operating on battery power, the battery should be replaced to ensure the back-up source has proper charge.
- For complete information, refer to the Temperature Chart Recorder Operation and Service Manual.

The chart recorder has a back-up battery system, enabling a period of continuous operation if power is lost. Battery life varies by manufacturer as well as voltage level remaining. Providing full power is available, back-up power for the temperature chart recorder is available for up to 14 hours.

Prior to use:

Route the chart recorder probe through the top access port and place in the bottle with the primary monitor probe.

Set up and Operation

Access the chart recorder by pressing and releasing the door.

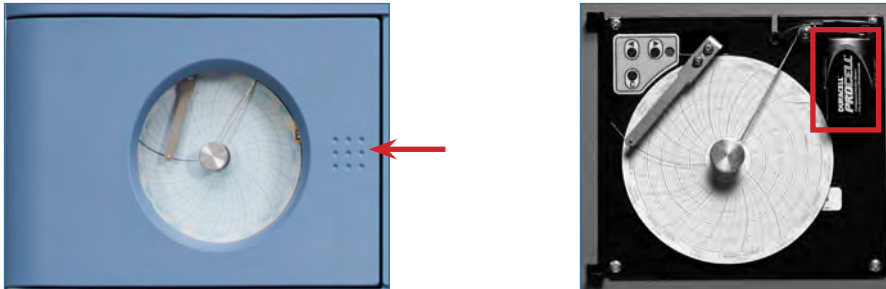

Install Battery

Connect the leads to the battery to provide back-up power to the chart recorder.

Install / Replace Chart Paper

Notes

- For accurate temperature reading, ensure the current time is aligned with the time line groove when the chart knob is fully tightened.
- Contact Helmer Customer Service or your distributor to reorder chart paper.

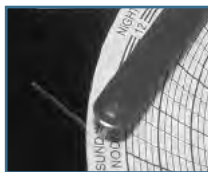

Chart recorder stylus and time line groove

1. Press and hold the **C** button. When the stylus begins to move left, release the button. The LED flashes.
2. When the stylus stops moving, remove the chart knob then move the knob up and away.
3. Place chart paper on the chart recorder.
4. Gently lift the stylus and rotate the paper so the current time line corresponds to the time line groove.
5. Hold the chart paper in place while making sure the chart knob is fully tightened. *(Failure to fully tighten the knob can result in paper slipping and losing time.)*
6. Press and hold the **C** button. When the stylus begins to move right, release the button.
7. Confirm the stylus is marking on the paper and stops at the correct temperature.
8. Calibrate the chart recorder to match the primary temperature if needed and close the recorder door.

External Monitoring Devices

The remote alarm interface is a relay switch with three terminals:

- ◆ Common (COM)
- ◆ Normally Open (NO)
- ◆ Normally Closed (NC)

Terminals are dry contacts and do not supply voltage. The interface circuit is either normally open or normally closed, depending on terminals used.

Requirements for your alarm system determine which alarm wires must connect to terminals.



- The interface on the remote alarm monitoring system is intended for connection to the end user's central alarm system(s) using normally-open or normally-closed dry contacts.
- If an external power supply exceeding 33V (RMS) or 30V (DC) is connected to the remote alarm monitoring system's circuit, the remote alarm will not function properly and may cause damage to the control board or result in injury to the user.

The terminals on the remote alarm interface have the following maximum load capacity:

- ◆ 115V or 230V: 1 A at 33V (AC) RMS or 30V (DC)



Connect to Remote Alarm Interface

1. Locate the remote alarm terminals on the side of the electrical compartment.
2. Connect the remote alarm wires to the appropriate terminals, according to the requirements for your alarm system.
3. Use a cable tie to relieve strain on the alarm wires (as necessary).

2.5 Configure Storage

Notes

- Before moving storage components, protect stored items in freezer from extended exposure to adverse temperature.
- Before moving drawers or shelves, ensure they are completely empty for safe lifting.
- Maximum drawer or shelf load is 100 lbs (46 kg).

Product Loading Guidelines

Note

Products stacked against the back wall may obstruct air flow and affect performance of the unit.

When loading your freezer, take care to observe the following guidelines:

- ◆ Never load the freezer beyond capacity.
- ◆ Always store items within shelves or drawers.
- ◆ Temperature uniformity is maintained by air circulation, which could be impeded if the unit is overfilled, particularly at the top or back. Ensure a minimum of 2" (50 mm) clearance is provided below the fan.

Drawers

Remove Drawer

1. Pull the drawer out until it stops.
2. Lift the front of the drawer off the front rollers on the slide.
3. With the front of the drawer slightly lifted, pull the drawer all the way forward. The rear drawer rollers should be touching the front slide rollers.
4. Lift the drawer to free from the slides.

Install Drawer

1. Align the rear rollers on the drawer with the opening just behind the front slide rollers.
2. Place the rear drawer rollers on the slides and gently push the drawer into the chamber until it stops.
3. Pull the drawer out until it stops to check for smooth operation.

Move Drawer Slides

1. Using a screwdriver, remove the bracket retainers.
2. Tap the brackets upward to disengage from standards.
3. Remove the slides from the standards.
4. Insert the slides into the standard at the appropriate height.
5. Tap the brackets downward to engage with standards.
6. Using a screwdriver, install the bracket retainers.

Shelves

Remove Shelf

1. With one hand, lift the front edge of the shelf from the front brackets approximately 8 inches.
2. With the other hand, reach under the shelf and bump the rear edge of the shelf upward to disengage rear brackets.

Install Shelf

1. Insert the shelf into chamber, placing it on the rear brackets and with the front edge of the shelf angled upward approximately 8 inches.
2. Lower the front edge and gently bump the rear edge of the shelf downward to engage with brackets.
3. Pulling the shelf forward gently; the shelf should not disengage from the rear brackets.

Move Shelf Brackets

1. Using a screwdriver, remove the bracket retainers.
2. Tap the brackets upward to disengage from standards.
3. Remove the brackets from the standards.
4. Insert the brackets into the standard at the appropriate height.
5. Tap the brackets downward to engage with standards.
6. Using a screwdriver, install the bracket retainers.

3 Controls

i.Series models are equipped with the i.C³ monitoring and control system. The i.C³ system combines temperature control and monitoring into a single user interface.

Note

Please refer to the i.C³ User Guide for complete information regarding the i.C³ User Interface.

3.1 Home Screen and Screensaver

The Home Screen is the default screen and is displayed when:

- ◆ The Home icon is touched from any other screen.
- ◆ There is no interaction for two minutes on any screen other than those used to enter a password.



Home Screen



Screensaver

3.2 Home Screen Functions

Note

Refer to the i.C³ User Guide for options available on all i.C³ screens.

- ◆ View current interior cabinet temperature readings
- ◆ View current system time and date
- ◆ Access any of the five home screen applications (touch **i.C³ APPS** for additional applications)
- ◆ View information about current alarm events
- ◆ View whether the monitoring system is running on battery power
- ◆ Mute audible alarms
- ◆ View a graph of the chamber temperature
- ◆ View unit ID
- ◆ Shortcut to Event Log

3.3 Alarm Reference

If an alarm condition is met, an alarm activates. Some alarms are visual only; others are visual and audible. Some alarms are sent through the remote alarm interface. The table below indicates if an alarm is audible (A), visual (V), or sent through the remote alarm interface (R).

Table 2. i.Series Alarm Reference

Alarm	Alarm Type	Alarm	Alarm Type
High Temperature	A, V, R	Low Battery	V
Low Temperature	A, V, R	No Battery	A, V, R
Compressor Temperature	A, V, R	Probe Failure	A, V, R
Door Open (Time)	A, V, R	Communication Failure	A, V, R
Power Failure	A, V, R		



3.4 Settings



Through the i.C³ monitoring and control system, current settings may be viewed and changed. To view settings, touch **i.C³ APPS, Settings**. Use a touch-drag motion to scroll up or down to select the desired setting.

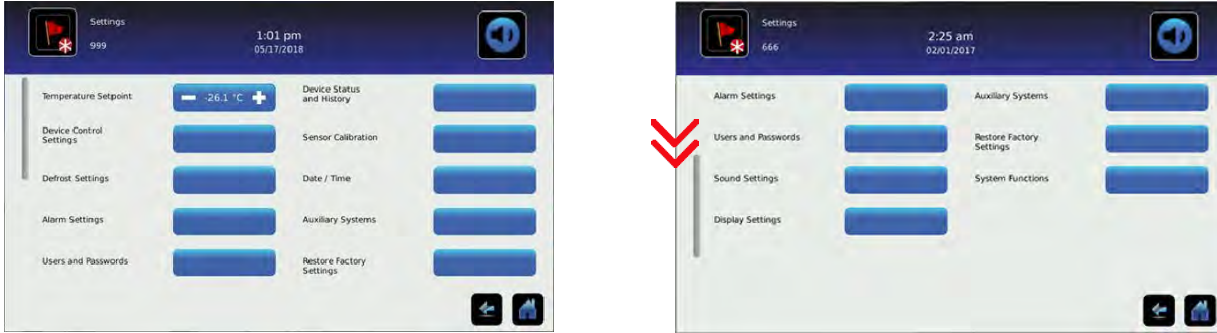

Settings screens

Notes

- If the Settings screen is password protected, enter the appropriate password. If viewing settings for the first time, enter the factory default password of “1234”.
- Default values for general settings, alarm settings, and display settings are available in the i.C³ User Guide.
- Changing temperature settings affects operation of the freezer. Do not change settings unless instructed in product documentation or by Helmer Technical Service.

The i.C³ temperature monitor and controller is programmed at the factory. To change a setting, first enter the Settings screen, then select the setting. The method for accessing the Settings mode for each setting varies.

Device Control Settings

Device control settings are programmed at the factory. Setpoints can be viewed and changed through the i.C³ monitoring and control system. To view temperature setpoints, touch **i.C³ APPS, Settings, Device Control Settings**.



Device Control Settings screen.

Table 3. Setpoints

Setting	Initial Factory Value
Temperature Setpoint	-30.0 °C
Upper Rail	0.7 °C
Lower Rail	-0.7 °C
Delay on Start-Up	2 minutes
Speed During Probe Error	50%

Note

For locations outside the U.S. and Canada, the default Temperature Setpoint for plasma freezers is -35.0 °C.

Temperature Setpoint

The setpoint is the temperature at which the freezer operates. The factory default setting for the primary monitor probe is -30.0°C. For locations outside the U.S. and Canada, the factory default setting for plasma freezers is -35.0 °C.

Notes

- If the Settings screen is password protected enter the appropriate password. If viewing settings for the first time, enter the factory default password of “1234”.
- Temperature Setpoint can be adjusted through the main Settings screen and Device Control Settings screen.
- Change the setpoint if your organization requires a chamber temperature other than the factory default.

Change Temperature Setpoint

1. Touch **i.C³ APPS, Settings**.
2. Enter the Settings password.
3. Touch the minus (–) or plus (+) on the **Temperature Setpoint** spin box to select the desired value.

Upper Rail

Upper rail is the maximum control temperature at which the compressor will turn on.

Lower Rail

Lower rail is the minimum control temperature at which the compressor will turn off.

Delay on Start-Up

Compressor startup is delayed to allow the i.C³ monitoring and control system to start first.

Speed During Probe Error

The compressor will run as a percent of maximum if both the monitor and control probe fail.

NOTICE

Upper Rail, Lower Rail, Delay on Start-up and Speed During Probe Error are factory-preset and should not be changed unless directed by Helmer Technical Service.

Defrost Time

Notes

- Depending on the high temperature alarm setpoint and the actual temperature increase during the defrost cycle, frequent door openings may trigger repeated high temperature alarms.
- There must be a minimum of four hours between defrost cycles.

Defrost events may be scheduled to occur at specific times. A defrost event can be triggered on demand without affecting a programmed defrosting schedule. The number of programmed defrost events is dependent on environmental conditions and the frequency of usage. The recommended number of daily defrost cycles is three to four, at even intervals. Defrost events should take place when the freezer door is likely to remain closed or opened infrequently.

The i.C³ monitoring and control system can perform a maximum of four defrost cycles per day.

Schedule or Start a Defrost Event

1. Touch **i.C³ APPS, Defrost Settings**.
2. Toggle the **ON/OFF** button to schedule the defrost event(s), or Toggle the **Start/Stop** button. The Defrost icon will appear for the duration of the defrost cycle.
3. Touch the corresponding Time spin box to set the starting time for each defrost event selected.

Table 4. Default Defrost Cycles

Defrost Event	On/Off	Default Time
1	On	12:15 AM
2	On	8:00 AM
3	On	4:00 PM
4	Off	6:00 PM

User Configurable Alarm Settings

The following alarm settings may be changed by the operator. The setpoint for temperature alarms may be changed (where applicable), as well as the time delay between when the alarm condition commences and when the visual and audible alarms are initiated.

Table 5. User Configurable Alarms

Alarm	Description	Default Value	Default Time Delay
Primary Monitor Probe High Temp	High temperature at which alarm condition occurs	-20°C -25°C*	0 minutes
Primary Monitor Probe Low Temp	Low temperature at which alarm condition occurs	-35°C -40°C*	0 minutes
Compressor High Temp	High temperature at which alarm condition occurs	50 °C	0 minutes
Power Failure	Time after power failure occurs until alarm sounds	-	1 minute
Probe Failure	Time after probe failure occurs until alarm sounds	-	0 minutes
Door Open (Time)	Time door remains open until alarm sounds	-	3 minutes

* Factory default value for plasma freezers for locations outside the U.S. and Canada.

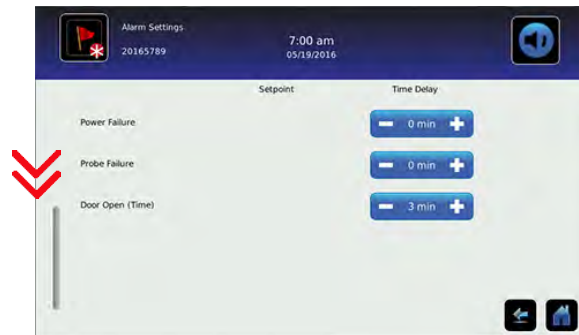

Alarm setting screens

i.Series

 **Change an Alarm Setting**

1. Touch **i.C³ APPS, Settings**.
2. Enter the Settings password (default password is “1234”).
3. Scroll down and touch **Alarm Settings**.
4. Touch the minus (-) or plus (+) on the spin box corresponding to the alarm setting to be changed.
5. Touch the minus (-) or plus (+) on the corresponding Time Delay spin box to change the time delay duration.
6. Touch **Home** to exit the Alarm Settings screen.

Non-Configurable Alarms

The following alarms indicate operational conditions which require the attention of the operator or a qualified service technician.

Table 6. Non-Configurable Alarm

Alarm	Description
Low Battery	Monitoring system rechargeable battery voltage is low
Drive Space Low	<ul style="list-style-type: none"> • Triggered if SD card containing downloadable historical data is approaching capacity • New data will continue to be saved for up to 3 more months • Data can be downloaded, but doing so will not free up capacity (SD card replacement recommended)
Drive Space Full	<ul style="list-style-type: none"> • Triggered if the SD card containing downloadable historical data has reached its capacity • No new data will be saved • Data can be downloaded, but doing so will not free up capacity (SD card replacement required)
Communication Failure	<p>Communication Failure 1</p> <ul style="list-style-type: none"> • Triggered if communication is lost between i.C³ display board and control board. • Unit will continue to run with previously saved settings • Screen will not display temperature changes or alarm conditions • i.C³ system will continue to reset until connection is re-established <p>Communication Failure 2</p> <ul style="list-style-type: none"> • Triggered if communication is lost between i.C³ display board and internal system memory • Unit will continue to run with previously saved settings <p>Communication Failure 3</p> <ul style="list-style-type: none"> • Triggered if the database is corrupted • The database is archived and a new database is automatically created • Unit will continue to run with previously saved settings
Inverter Communication Failure	<ul style="list-style-type: none"> • Triggered if there is a problem with the refrigeration system <p>Contact Helmer Technical Service for more information</p>



3.5 Sensor Calibration



Sensor calibration values are programmed at the factory. Calibration values can be viewed and changed through the i.C³ monitoring and control system. To view calibration settings, touch **i.C³ APPS**, **Settings**, and select **Sensor Calibration**.

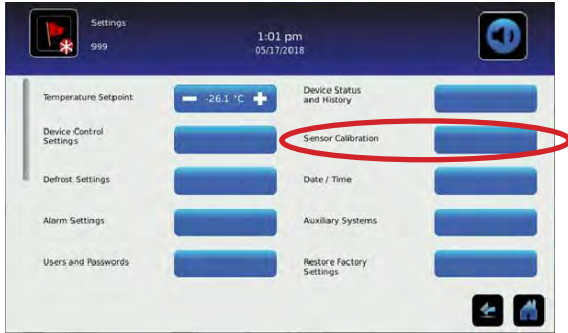

Settings Screen

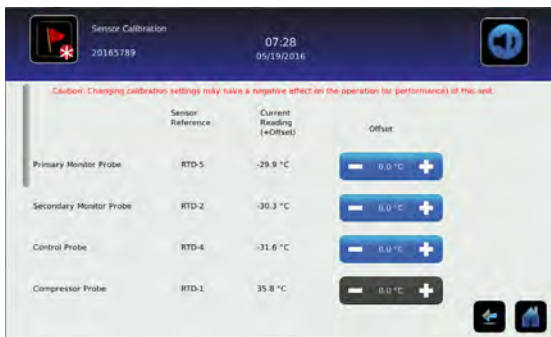

Sensor Calibration screens

Notes

- If the Settings screen is password protected enter the appropriate password. If viewing settings for the first time, enter the factory default password of "1234".
- Offset values are adjusted to the tenth of a degree (0.1).
- After one hour of no interaction, the Home screen or Temperature Graph screensaver (if enabled) is displayed.
- The Compressor Probe offset and Evaporator Defrost Probe offset are factory-preset and should not be changed unless directed by Helmer Technical Service.

View Sensor Calibration Values

1. Touch the **Settings** icon.
2. Enter the Settings password.
3. Touch **Sensor Calibration**. The sensor offset values and their current temperature readings are displayed.
4. Touch **Home** to return to the Home screen.

i.Series

Primary Monitor Probe

Verify the primary monitor probe is reading the chamber temperature correctly by comparing the probe reading to the temperature measured by a calibrated reference thermometer. If the probe is not reading correctly, change the value displayed on the monitor.

The factory default setting for the primary monitor probe is -30.0°C. For locations outside the U.S. and Canada, the factory default setting for plasma freezers is -35.0 °C.

Notes

- Ensure the product simulation bottle is full of solution.
- The probe in the bottle is connected to the monitoring system and senses chamber temperature. This probe activates the temperature alarms but does not affect temperature control.

Calibrate Primary Monitor Probe

1. Remove the primary monitor probe from the probe bottle.
2. Unscrew the cap from the bottle.
3. Attach a calibrated independent reference thermometer traceable per national standards to the primary monitor probe, and place them in the bottle. The probe and thermometer should be immersed at least 2" (50 mm).
4. Close the door and allow the chamber temperature to stabilize.
5. Observe and note the thermometer temperature. If the independent thermometer corresponds to the displayed temperature, proceed to **Step 11**.
6. Subtract the displayed temperature reading from the independent probe reading to determine the offset value.
7. Enter the Settings password (default password is "1234").
8. Touch, **i.C³ APPS, Settings**.
9. Touch **Sensor Calibration**.
10. Touch the minus (-) or plus (+) on the **corresponding** spin box to increase or decrease the value by the value calculated in **Step 6**. The message "New Setting Saved" appears next to the spin box.
11. Remove the thermometer from probe.
12. Replace and secure the bottle cap, ensuring a tight fit.
13. Place the probe in the bottle, immersing at least 2" (50 mm).

Control Probe

The temperature controller senses unit cooler temperature through the control probe in the unit cooler. The unit cooler temperature typically varies from the chamber temperature, so an offset value is used by the control system to compensate for the difference.

Chamber temperature will be controlled as required to match the temperature set point based on the control probe reading.

Determine Control Probe Offset

NOTICE

- Control Probe Offset is factory-preset and should not be changed. Contact Helmer Technical Service for instructions regarding changing the Control Sensor Offset.
- Monitor temperature must be verified and accurate prior to adjusting the Control Sensor Offset.

1. View and record the Freezer Setpoint.
2. Allow the unit to run with a calibrated monitor temperature for several compressor cycles, and record the average monitor temperature.
3. View and record the current Control Offset value.
4. Subtract the Freezer Setpoint from the average monitor temperature and record the difference.
5. Add the current Control Offset value to the recorded difference determined in the previous step to establish the new Control Offset value.

Example 1	Example 2
Freezer setpoint is -30.0	Freezer setpoint is -30.0
Average monitor temperature is -29.2	Average monitor temperature is -31.2
Current Control Offset is 0.3	Current Control Offset is 0.3
Subtract: $-29.2 - (-30.0) = 0.8$ (difference between average temperature and setpoint)	Subtract: $-31.2 - (-30.0) = -1.2$ (difference between average temperature and setpoint)
Add: $0.3 + 1.2 = 1.5$ (new control offset value)	Add: $0.3 + (-1.2) = -0.9$ (new control offset value)

 **Enter New Offset Value:**

1. Touch **i.C³ APPS, Settings**.
2. Enter the Settings password (default password is “1234”).
3. Touch **Sensor Calibration**.
4. Touch the minus (–) or plus (+) on the **Control Probe Offset** spin box.
 - ◆ Raise the offset value to lower chamber temperature; lower the offset value to raise chamber temperature.
5. Touch **Home** to return to home screen.

Compressor Probe

The compressor temperature probe has been factory-calibrated. Changing the calibration setting is not typically necessary and should not be performed unless directed by Helmer Technical Service.

Factory Default Settings

Settings listed below may be simultaneously returned to factory default values.

 **Note**

The factory default settings may not be the same as the settings that were factory-calibrated before the freezer was shipped.



Table 7. Default Settings

Setting	Restored Value	
Home Screen Application Icons	i.C ³ APPS, Settings, Temperature Graph, Temperature Alarm Test, Information Logs	
Display Brightness	High (level 3)	
Password (for Settings screen)	1234	
Sounds	On	
Alarm Volume	9	
Alarm Tone	3	
Temperature Calibration Values	Not affected (values previously entered during setup)	
Unit ID	Not affected (previously selected during setup)	
Date Format	MM/DD/YY	
Day	Not affected (maintained in real-time clock)	
Month		
Year		
Time Format	12-hour	
Minute	Not affected (maintained in real-time clock)	
Hour		
AM/PM		
Language	Not affected (Language previously selected during setup)	
Temperature Units	°C	
Password Protection (for Settings screen)	On	
Temperature Graph Screensaver	On	
Access Control (optional) as Home Page	On	
High Temperature Alarm Setpoint	-20.0 °C	-25.0 °C*
High Temperature Alarm Time Delay	0 minutes	
Low Temperature Alarm Setpoint	-35.0 °C	-40.0 °C*
Low Temperature Alarm Time Delay	0 minutes	
Power Failure Alarm Time Delay	1 minute	
Probe Failure Alarm Time Delay	0 minutes	
Door Open (Time) Alarm Time Delay	3 minutes	
Compressor Temperature Alarm Setpoint	50.0 °C	
Compressor Temperature Alarm Time Delay	1 minute	

Setting	Restored Value	
Chamber Setpoint	-30 °C	-35 °C*
Upper Rail	0.7 °C	
Lower Rail	-0.7 °C	
Delay on Start-Up	2 minutes	
Speed During Probe Error	50%	

* Factory default setpoints for plasma freezers for locations outside the U.S. and Canada.

Restore Settings:

1. Touch the **Settings** icon.
2. Scroll down and touch the **Restore Factory Settings** button. The Restore Factory Settings confirmation box appears.
3. Touch  to restore the factory settings or  to maintain the current settings and clear the message.

4 Maintenance

Maintenance tasks should be completed according to the schedule below. Refer to the i.C³ User Guide for more detail on completing various tasks.

Notes

- The preventive maintenance schedule provides recommended minimum requirements. Regulations or physical conditions at your organization may require maintenance items be performed more frequently, or only by designated service personnel.
- Before performing maintenance, protect items in the freezer from extended exposure to adverse temperature.
- Allow the freezer temperature to stabilize at the setpoint after performing service or after extended door opening.

Table 8. i.Series Preventive Maintenance Schedule

Task	Frequency			
	1 year	2 years	5 years	As Needed
Test the high temperature <i>(over maximum temperature limit)</i> or low temperature <i>(below minimum temperature limit)</i> alarms <i>(as required by your organization's protocols)</i> .				✓
Test the power failure alarm <i>(as required by your organization's protocols)</i> .				✓
Test the door alarm <i>(as required by your organization's protocols)</i> .				✓
Verify the temperature calibration on the monitor and change it if necessary.	✓			
Replace monitoring system back-up battery.		✓		
Examine probe bottle(s) and clean or replace if necessary.	✓			
Check the solution level in the probe bottle. Refill or replace if necessary.				✓
Replace Display Board CR2032 battery.				✓
Clean the door gaskets, interior, and exterior of the freezer.				✓
Clean the condenser grill.				✓
Models with chart recorders				✓
Check the back-up battery for the chart recorder after an extended power failure and change it if necessary, or change the battery if it has been in service for one year. Refer to the Temperature Chart Recorder Operation and Service Manual.				✓

NOTICE

- Clean the condenser grill regularly. Dust accumulation on the condenser coil will vary based on the environment. Some environments require quarterly cleaning.
- Some equipment surfaces may be sharp. Take care when cleaning to avoid injury.

Notes

- During a power failure the back-up battery provides power to the monitoring system, power failure alarm, and optional Access Control. If the back-up battery is not functioning, the power failure alarm will not be activated and the battery should be replaced.
- During a power failure, the back-up battery continues to provide power to the optional Access Control lock (if equipped). If the back-up battery is not functioning, the optional Access Control lock will not secure the door.

i.Series

4.1 Alarm Tests

Test alarms to ensure they are working correctly. The freezer has alarms for chamber temperature, compressor temperature, power failure, probe failure, and door open (time).

Automatic Chamber Temperature Alarm Test



Temperature Alarm Test screen

Notes

- Test can be aborted by touching **Cancel Test**.
- Test is only applicable to the primary monitor probe.
- Test takes less than five minutes.
- If the temperature alarm test does not complete successfully, restart the i.C³ monitoring system.

When performing an automatic temperature alarm test, the Peltier device heats or cools the primary monitor probe until the high or low alarm setpoint is reached. An event is added to the Event Log to indicate a temperature alarm was activated. The Alarm Test icon is displayed on the Temperature Graph to indicate the temperature alarm was test-induced.

Test the Low Alarm:

1. Identify the current setting for the low alarm setpoint.
2. Touch **i.C³ APPS, Temperature Alarm Test**.
3. Touch **Low Alarm Test**.
4. “Peltier Test Probe Cooling” message appears.
5. When the displayed temperature reaches the alarm setpoint, an alarm is activated.
6. When completed, “Test Complete” appears.
7. Touch **i.C³ APPS, Information Logs, Event Log**. Touch the event to view event details.
8. Observe the temperature at the time of the low temperature alarm event. Compare this to the alarm setpoint.



Test the High Alarm:

1. Identify the current setting for the high alarm setpoint.
2. Touch **i.C³ APPS, Temperature Alarm Test**.
3. Touch **High Alarm Test**.
4. “Peltier Test Probe Warming” message appears.
5. When the displayed temperature reaches the alarm setpoint, the temperature reading turns red.
6. When completed, “Test Complete” appears.
7. Touch **i.C³ APPS, Information Logs, Event Log**. Touch the event to view event details.
8. Observe the temperature at the time of the high temperature alarm event. Compare this to the alarm setpoint.



Cancel the Test:

1. Touch **Cancel Test** icon to end the alarm test. “Test Stopped” is displayed in the Test Status section of the display.

Note

When cancelling an automatic test, the message indicating the test is in progress clears immediately. If a setpoint was reached before the test was cancelled, the alarm activates and clears as described previously.

Manual Chamber Alarm Test

NOTICE

- Before testing alarms, protect items in the unit from extended exposure to adverse temperature.
- Temperature probes are fragile; handle with care.

Test the High Alarm:

1. Identify the setting for the high alarm setpoint.
2. Place a glass of product simulation solution in the freezer.
3. When the product simulation solution has stabilized at the chamber temperature, remove the solution from the freezer.
4. Remove the monitor probe from the probe bottle and insert into the product simulation solution.
5. Observe the temperature on the i.C³ display at which the high temperature alarm sounds.
6. Compare the temperature at which the alarm sounds to the high alarm setpoint.
7. Remove probe from the product simulation solution.
8. Place the monitor probe in the probe bottle, immersing it at least 2" (50 mm).

Power Failure Alarm Test

Note

During a power failure, the power failure alarm sounds and the battery provides power to the monitoring system and optional Access Control lock.

1. Change the Power Failure delay setting to 0 minutes by touching **Home, Settings**
2. Enter the Settings password (default password is "1234").
3. Touch **Alarm Settings**, then touch (+) or (–) on the Power Failure spin box to change the value to 0.
4. Switch the AC power switch OFF. The power failure alarm will activate immediately.
5. Switch the AC power switch ON. The power failure alarm will clear and the audible alarm will cease.
6. Change the Power Failure time delay to the original setting.

Door Open Alarm Test

1. Change the Door Open (Time) delay setting to 0 minutes by touching **Home, Settings**,
2. Enter the Settings password (default password is "1234").
1. Touch **Alarm Settings**, then touch (+) or (–) on the Door Open (Time) spin box to change the value to 0.
2. Open the door. The alarm will activate immediately.
3. Close the door. The alarm will clear, and the audible alarm will cease.
4. Change the Door Open (Time) setting to the original setting.

4.2 Test and Replace Back-up Batteries

i.C³ Monitoring System Back-up Battery

On all i.C³ screens, the Battery icon will appear in the header bar when the system is running on battery power and the screen brightness will automatically be reduced. The monitoring system will automatically disable some features to extend battery life.

Check the Battery.

1. Switch the AC power switch OFF.
2. The screen should continue to display information with reduced brightness and the battery icon will appear on the screen. If the display is blank, replace the battery.
3. When completed, switch the AC power switch ON.

Note

Use only a battery which meets manufacturer's specifications.

Access Control Back-up Battery (Optional)

During an AC power failure, the Access Control back-up battery provides back-up power to operate the magnetic Access Control lock.

Test Access Control Back-up Battery.

1. Ensure the monitoring system/Access Control battery key switch is switched ON.
2. Switch AC power switch OFF.
3. Attempt to open the cabinet door.
4. If the door remains locked, the battery is functional.
5. If the door does not remain locked, replace the battery.
6. Switch AC power switch ON.

Remove and Replace Battery



Take care not to short the battery terminals to the bracket or to each other when removing or attaching terminal connectors, bracket or bracket screws.

1. Switch the battery back-up switch OFF; switch the AC power switch OFF; disconnect the AC power cord from the power receptacle.
2. Using a #2 Phillips screwdriver, remove the four screws securing the access panel to the top cover to the unit. Set the panel and screws aside.
3. Locate the 12V battery, remove the wires from the terminals.
4. Using a #2 Phillips screwdriver remove the screw from the mounting bracket, and remove the old battery.
5. Place the new battery in the same location as the one removed.
6. Install the bracket over the battery and secure with the screw.
7. Reconnect the wires to the correct terminals.
8. Replace the access panel and secure with four screws using a #2 Phillips screwdriver.
9. Reconnect the AC power cord; switch the AC power switch to ON; switch the battery back-up switch to ON.

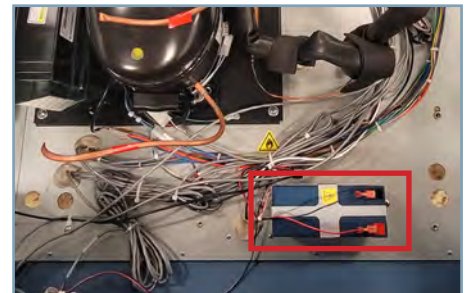

Chart Recorder Back-up Battery (if included)

Refer to Temperature Chart Recorder Operation and Service Manual.

4.3 Check Probe Bottle(s)

Remove the probe bottle(s) from the bracket(s) and inspect for cracks. Replace the bottle(s) if necessary.

Ensure the probe bottle has approximately 4 oz. (120 mL) of product simulation solution (1:1 ratio of water to propylene glycol). The propylene glycol is used to create a solution which simulates the product stored in the freezer. The product simulation solution temperature reflects the product's temperature during normal operation. Failure to fill the bottle may prevent the chamber temperature from stabilizing at the temperature setpoint. The probe should be immersed at least 2" (50 mm).

4.4 Display Board Battery

NOTICE

The display board is sensitive to static electricity and can be damaged by electrostatic discharge. Use proper ESD precautions when handling the display board.

Replace Display Board Battery

1. Switch the AC power switch OFF, switch the battery back-up and Access Control switches OFF; disconnect the AC power cord from the power receptacle.
2. Use a #2 Phillips screwdriver to remove two screws from the bottom of the i.C³ bezel.
3. Gently lift the bezel to disconnect it from the mounting bracket on the front of the unit.
4. Locate the CR2032 battery. Use a small flat head screwdriver to push the old battery out of the slot.
5. Install a new CR2032 battery into the slot.
6. Mount the bezel to the cabinet using two screws.
7. Reconnect the AC power cord; switch the AC power switch ON; switch the battery back-up switch ON.

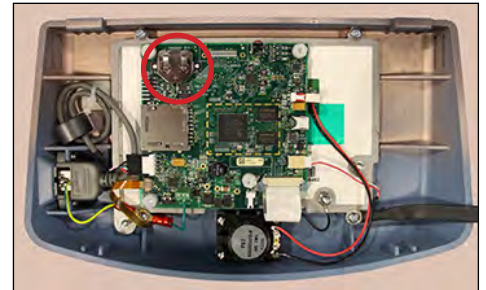

4.5 Upgrade System Firmware

Helmer may occasionally issue updates for the i.C³ firmware. Follow the upgrade instructions included with the firmware update.

4.6 Clean the Freezer

Cabinet Exterior

Clean exterior surfaces with a soft cotton cloth and non-abrasive liquid cleaner.

Cabinet Interior

Clean painted surfaces with mild detergent. Clean stainless steel surfaces with a general-purpose laboratory cleaner suitable for stainless steel.

Condenser Grill



Disconnect the freezer from AC power when cleaning.

NOTICE

Some equipment surfaces may be sharp. Take care when cleaning to avoid injury.

If the freezer is located in an environment where it is exposed to excessive lint or dust, the condenser grill may require cleaning more frequently than stated in the preventive maintenance schedule.

Clean the condenser grill using a soft brush and a vacuum cleaner.

Door Gasket

Clean with a soft cloth and mild soap and water solution.

Probe Bottle(s)



Clean and Refill Probe Bottle(s)

1. Remove all probes from the bottle.
2. Remove the bottle from the bracket and empty any remaining solution.
3. Clean the bottle with a 1:9 ratio of bleach to water solution or a company approved cleaner/disinfectant.
4. Refill the bottle with 4 oz. (120 mL) of product simulation solution (1:1 ratio of water to propylene glycol).
5. Cap the bottle tightly to minimize evaporation.
6. Place the bottle in the bracket.
7. Replace the probe(s), immersing at least 2" (50 mm).

i.C³® Touchscreen

Clean the touchscreen with a soft, dry cotton cloth.

5 Service

5.1 Refrigerant



Risk of fire or explosion. Flammable refrigerant used. To be repaired only by trained service personnel. DO NOT puncture refrigerant tubing.

NOTICE

- Review all safety instructions prior to recharging refrigerant.
- Maintenance should only be performed by trained refrigeration technicians familiar with hydrocarbon refrigerants.

Table 9. Refrigerant Charge

Refrigerant	Initial Charge
R290	4.6 oz. (130.4 g +/- 1 g)

5.2 Remove/Replace Unit Cooler Cover

The unit cooler cover must be removed when servicing the control probe, defrost probe, heating pad, fan motor(s) or coil.

NOTICE

- If the unit cooler cover is not removed as detailed in this procedure the drain port may be damaged. Improper drainage may result in excessive icing and the freezer's inability to maintain temperature.
- Temperature probes are fragile; handle with care.

Note

The Cold-Shield™ (if installed) must be taken out prior to removing the unit cooler cover.

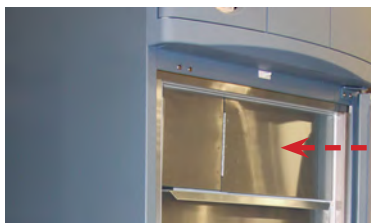

Cold-Shield



Cold-Shield (rear view)

Remove Cold-Shield™ (if installed)

1. Remove the top drawer from the cabinet (refer to Section 2.5).
2. From the back side of the Cold-Shield panel, loosen the three screws securing the Cold-Shield to the cabinet using a #2 Phillips screwdriver.
3. Slide the panel forward to remove.

Install Cold-Shield™ (if installed)

1. Reinstall Cold-Shield by aligning the slots in the panel with the screws in the cabinet and sliding inward.
2. From the back side of the panel, tighten the three screws securing the Cold-Shield to the cabinet using a #2 Phillips screwdriver.
3. Reinstall the top drawer in the cabinet.

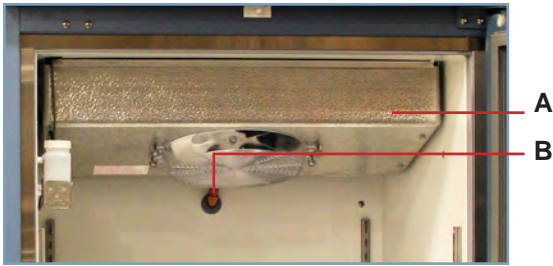

Label	Description
A	Unit cooler cover
B	Drain port

Unit cooler cover and drain port

Remove Unit Cooler Cover

1. Switch the AC power switch OFF. Switch the back-up battery switch OFF.

Steps 2 - 5 apply to 20 cu ft models only. All other models proceed to Step 6.

2. Carefully remove the probe from the probe bottle and unwind the probe wiring from the cleat. Allow the probe to hang along the side of the cabinet.
3. Remove the probe bottle from the bracket and set aside.
4. Loosen the two screws securing the probe bottle bracket using a #2 Phillips screwdriver. Remove the bracket and set aside.
5. Using a #2 Phillips screwdriver, remove the two screws securing the cleat from the side of the chamber. Set the cleat and screws aside.
6. Hold the unit cooler cover in place to prevent dropping. Using an 8mm socket driver, remove the four screws securing the unit cooler cover.
7. Carefully lower the unit cooler cover to avoid damage to the fan wiring.
8. Disconnect the fan motor and heating pad wire connections.
9. Once the cover is dropped down far enough to clear the rear of the evaporator, lift and pull the cover forward to unhook the drain tube connections from the cover.

Install Unit Cooler Cover

1. Insert the drain tube on the cover into the copper drain port in the back of the unit with the drain tube heater sticking through.
2. Reconnect the fan motor and heating pad wire connections and verify they are routed correctly.
3. Lift the unit cooler cover into place. The front edge of the cover should be behind the unit cooler case.
4. Secure the unit cooler cover with the four screws using an 8 mm socket driver.
5. Inside the unit, adjust the copper tubing onto the drain on the cover to make to ensure proper condensate drainage.
6. Reinstall the top drawer or shelf if previously removed.
7. Reinstall cleat, water bottle bracket and water bottle if previously removed.
8. Switch the AC power switch ON. Switch the back-up battery switch ON.
9. Touch **Mute** to disable the high temperature alarm while freezer reaches operating temperature.

i.Series

6 Troubleshooting

NOTICE

Review all safety instructions prior to troubleshooting.

6.1 Access System Problems

Problem	Possible Cause	Action
Door does not lock	Lock mechanism is damaged.	Inspect lock/latch, Replace if necessary.
Door does not lock (Magnetic Access Control Option)	Magnetic door lock is not aligned with the strike plate.	Align lock/door to the match strike plate.
	Magnetic lock is not receiving power.	Trace voltage to the lock using the schematic, replace lock if needed.

6.2 Alarm Activation Problems

Problem	Possible Cause	Action
Battery alarms	The battery switch is in the off "o" position.	Turn the key switch to the on "-" position.
	The battery is low due to a power failure.	Allow the battery to recharge.
	Faulty battery or wiring connection.	Check wiring and replace battery if needed.
Probe failure alarms	Faulty probe or wiring connection.	Check corresponding probe connection. Test resistance of probe (86 Ω to 110 Ω) Replace probe if needed.
Power failure alarm	Power was interrupted to freezer.	Restore facility power.
	Power switch is in the off "o" position.	Turn power switch to the on "-" position.
	Power cord is loose.	Check both ends of the power cord at the wall outlet and the freezer.
	GFI/GFCI Outlet has tripped.	Move to standard outlet. Helmer does not recommend operating this unit on a GFI outlet.
Door alarm	Door is open.	Close door.
	Door alarm delay is set to 0 min.	Check door alarm delay (3 min default setting).
	Faulty door switch or wiring connections.	Check wiring and continuity of switch contacts. Replace switch if needed.
Compressor alarm	Condenser coil is dirty.	Clean condenser coil.
	Condenser probe is out of calibration.	Calibrate probe.
	Condenser probe is faulty.	Check corresponding probe connection. Test resistance of probe (86 Ω to 110 Ω) Replace probe if needed.
	Ambient conditions are outside of specifications.	Ensure ambient conditions are within specifications.
Communication alarms	Communication between circuit boards is lost.	Reboot/power cycle the freezer. Turn off both main power and battery power, then turn power back on.

6.3 Chamber Temperature Problems

Problem	Possible Cause	Action
Temperature display does not match actual temperature.	Display temperature needs to be calibrated.	Follow temperature calibration process.
	Probe bottle is empty, or probe is out of bottle.	Check level of solution in bottle(s) and or insert probe into bottle.
Chamber temperature is too high/low.	Probe bottle is empty, or probe is out of bottle.	Check level of solution in bottle(s) and or insert probe into bottle.
	Display temperature needs to be calibrated.	Follow temperature calibration process.
	Door was recently opened or opened for an extended time.	Close door and allow temperature to stabilize.
	Condenser coil is dirty.	Clean the condenser coil regularly, removing all dust build up.
	Lack of air flow around unit/high ambient condition.	Check for proper spacing around unit, any foreign objects blocking airflow, and that ambient temperature is within specification.
	Lack of air flow inside of chamber.	Verify product placement and move products if they block air flow around evaporator fan, or product hanging over the shelves against back wall.
	Temperature setpoint was adjusted.	Check temperature setpoint and temperature settings. Change to default settings or desired setpoint.
	Control probe is reading too high/low.	Check control offset setting, adjust if needed.
	Unit cooler fan motor (inside chamber) is not running.	Check voltage to the fan motor using schematic, replace fan motor if needed.
	Condenser fan motor (exterior) is not running.	Check voltage to the fan motor using schematic, replace fan motor if needed.
	Compressor is not running.	Check voltage to the compressor using schematic, replace compressor start components if needed.
Ice build up in unit cooler.	See entry in Section 6.4	

i.Series

6.4 Condensation and Icing Problems

Problem	Possible Cause	Action
Excess frost/ice in chamber.	Some frost/ice within the freezer chamber is normal.	No action needed. Defrost the chamber if needed by turning the freezer off and leaving the door open until thawed, dry interior with cloth.
	Frequent or extended door openings.	Close the door and defrost chamber if needed.
	Chamber is not sealed.	Inspect door seal for damage, replace if needed. Check for wires routed through the door seal, reroute wires to the available though hole if needed. Check through holes and ensure they are sealed, reseal if needed.
	Automatic defrost cycle is not working.	Check defrost settings and test defrost cycle to determine issue.

7 i.Series Parts

Notes

- Before replacing parts, protect items in freezer from extended exposure to adverse temperature.
- Allow freezer temperature to stabilize at setpoint after replacing parts or after extended door opening.
- Circuit boards are sensitive to static electricity and can be damaged by electrostatic discharge. Use proper ESD precautions when handling the display assembly.



i.Series

Letter	Description	Part Number	Letter	Description	Part Number
A	Temperature chart recorder	400409-6	E	Caster - swivel with brake	220467
B	Stylus arm and pen	400505-1	F	Display assembly	800042-1
C	Chart paper (52 sheets)	220419	G	Primary monitor probe	800038-1
Not shown	Chart recorder back-up battery	120218	Not shown	Secondary monitor probe	800037-1
D	Latching door handle	220426	Not shown	Chart recorder probe	400799-1
Not shown	Strike Plate	801174-1	H	Probe bottle and propylene glycol kit	400922-2

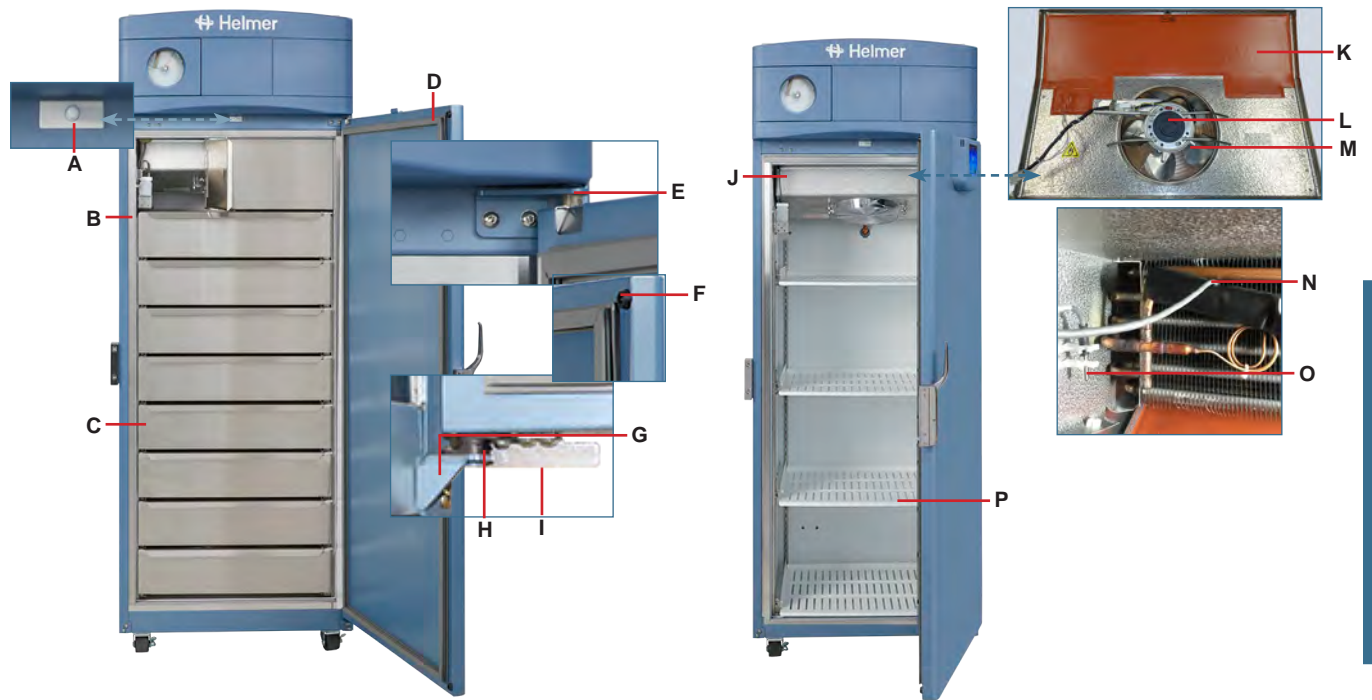

i.Series

Letter	Description	Part Number	Model	Volts	Letter	Description	Part Number	Volts
A	Door switch	120380	-	-	H	Lower hinge cam	320742-1	-
B	Mullion heater (behind strike plates)	800883-1	-	115	Not Shown	Lower hinge bearing	220375	-
		800884-1	-	230	I	Door stop	320763-1	-
C	Drawer assembly (includes hardware and slides) * 20 cu ft units; ** 25 cu ft units	801131-1*	-	-	J	Evaporator assembly	801083-1	115
		801123-1**	-	-			801084-1	230
Not Shown	Ventilated Drawer (white)	402322-1-069	120	-	K	Evaporator cover heater	801089-1	115
Not Shown	Drawer Vent	801129-1	125	-			801090-1	230
D	Door gasket	801038-1	-	-	L	Evaporator fan motor	801114-1	-
E	Upper hinge assembly * right assembly; ** left assembly	801152-1*	-	-	M	Evaporator fan blade	220779	-
		801156-1**	-	-	N	Defrost probe	800039-1	-
F	Door bumper	220441	-	-	O	Control probe	800048-1	-
G	Lower hinge bracket * right assembly; ** left assembly	801142-1*	-	-	P	Ventilated shelf * 20 cu ft units; ** 25 cu ft units	801116-1*	-
		801172-1**	-	-			801115-1**	-



Risk of fire or explosion. Flammable refrigerant used. To be repaired only by trained service personnel. DO NOT puncture refrigerant tubing.

NOTICE

Disconnect unit from AC power before accessing the electrical compartment.

Note

Circuit boards are sensitive to static electricity and can be damaged by electrostatic discharge. User proper ESD precautions when handling board.

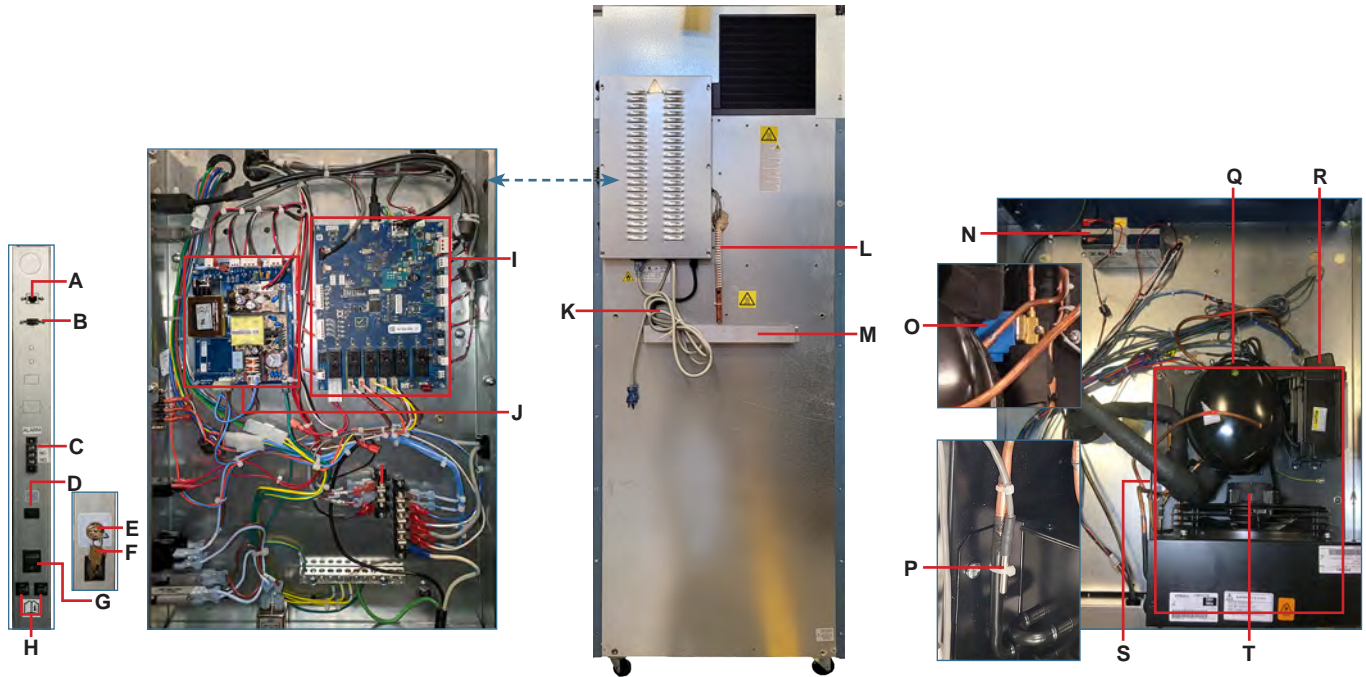

i.Series

Letter	Description	Part Number	Volts	Letter	Description	Part Number	Volts
A	RJ45 Ethernet port	-	-	M	Condensate evaporator tray assembly	801167-1	115
B	USB port	-	-			402326-2	230
C	Remote alarm contacts	-	-	N	Monitoring system battery (optional Access Control)	121018	-
D	Back-up battery switch (no Access Control)	-	-	O	Defrost Solenoid	801166-1	115
E	Back-up battery key switch (with Access Control)	120754	-			801171-1	230
F	Back-up battery key	120895	-	P	Condenser probe	800039-1	-
G	Main power switch	120478	-	Q	Compressor	-	-
H	Circuit breaker (qty 2, 12A)	120287	-	R	Compressor inverter	801087-1	115
I	i.C ³ control board	800034-4	-			801088-1	230
J	i.C ³ power supply board	800916-1	-	S	Condensing unit (includes condenser and compressor)	801085-1	115
K	Power cord	120630	115			801086-1	230
L	Drain line heater	801163-1	115	T	Condenser fan motor assembly	120985	-
		402302-1	230				

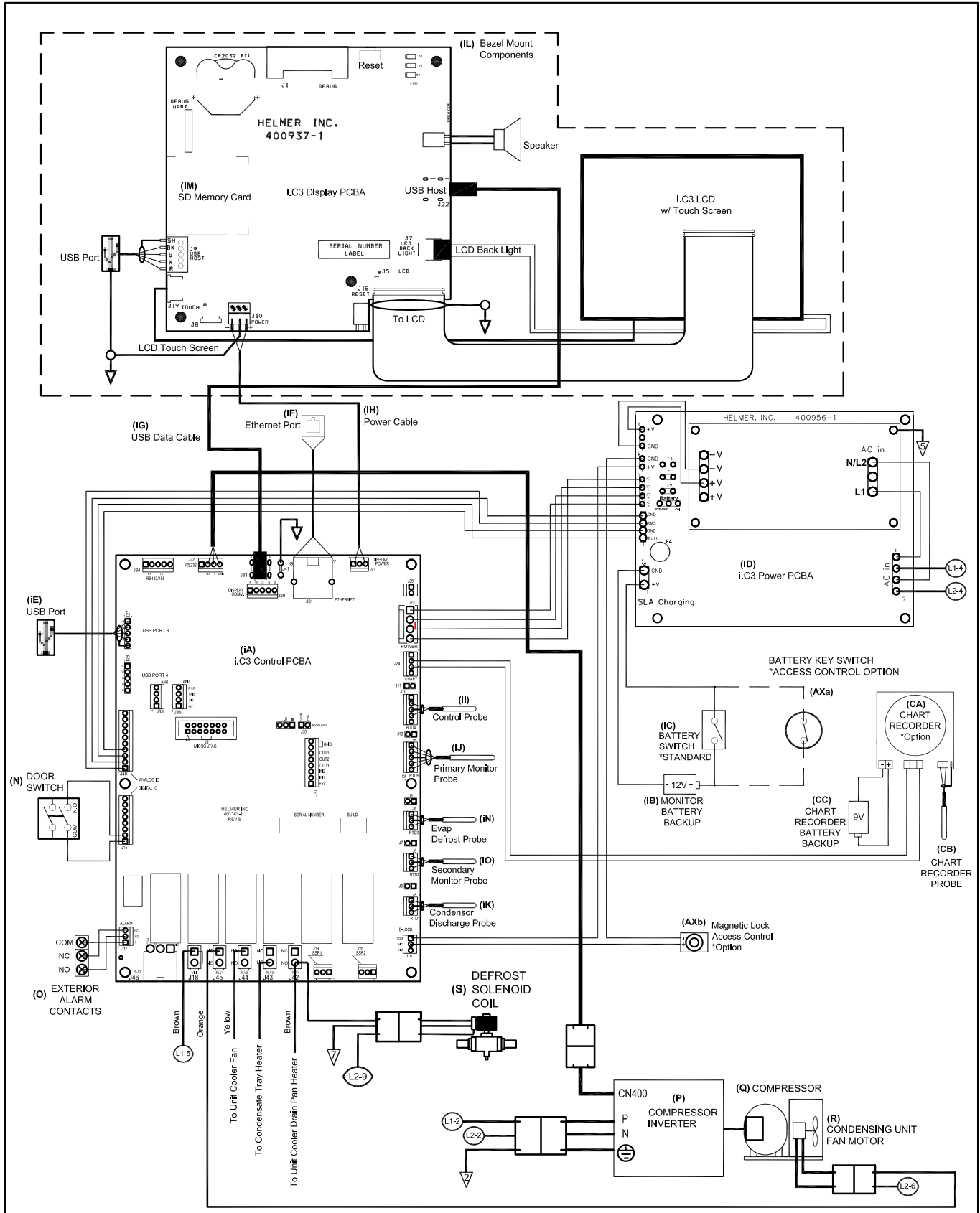

i.Series

Horizon Series Information

9 Installation and Configuration

9.1 Location Requirements



Keep all ventilation openings in the enclosure or, in the structure for building-in, clear of obstruction.

- ◆ Has a grounded outlet meeting the electrical requirements listed on the product specification label.
- ◆ Is clear of direct sunlight, high temperature sources, heating vents, and air conditioning vents.
- ◆ Has a minimum of 8" (203 mm) above, and a minimum of 3" (76 mm) behind the unit for proper ventilation, clearance, and feature access.
- ◆ Meets specified limits for ambient temperature and relative humidity as stated in the Product Specifications section of the Instructions for Use manual.

9.2 Placement and Leveling

NOTICE

- Helmer does not recommend operating this unit on a GFI/GFCI outlet.
- To prevent tipping, ensure the casters are unlocked and the door is closed before moving the freezer.
- To avoid damaging refrigerant tubing or risking refrigerant leak, use caution when moving or operating the unit.
- Use of leveling feet or casters is required.

1. Ensure the door is secured and casters are unlocked.
2. Move the freezer into place. Lock the casters.
3. Ensure the freezer is level.

9.3 Connect Back-Up Power

The monitoring system, optional Access Control and chart recorder each have a back-up battery system enabling a period of continuous operation if power is lost.

Battery life varies by manufacturer as well as voltage level remaining. Providing full battery power is available, back-up power for the monitoring system is available for up to two hours. Providing full power is available, back-up power for the optional Access Control system is available for up to 2.5 hours.



Before installing or replacing batteries, switch main power OFF. Disconnect freezer from AC power.

Notes

- The optional Access Control system uses an independent battery for back-up power.
- If AC power is lost, the monitoring system will automatically disable some features to prolong back-up battery power. Data collection will continue until back-up battery power is depleted.

The monitoring system and optional Access Control back-up batteries are located on top of the freezer. A removable panel provides access to the back-up batteries.

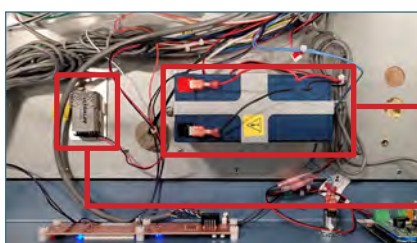

Optional Access Control back-up battery.

Monitoring system back-up battery.

9.4 Defrost Events

The number of defrost events is dependent on environmental conditions and the frequency of usage. Each unit may have up to four programmable defrost event cycles per 24 hours. The frequency of events is determined by switch settings on the control board. The freezer ships from the factory with three preprogrammed defrost events per 24 hours. Defrost events are timer based recurring every eight hours with the first beginning eight hours after initial power up.

A manual defrost event may be initiated through the manual defrost momentary push button on the control board. Access to the manual defrost button is available from the back of the freezer by removing the panel to access the control board. To optimize defrost system effectiveness, ensure manual defrost events are initiated at times when the freezer door is likely to remain closed or opened infrequently.

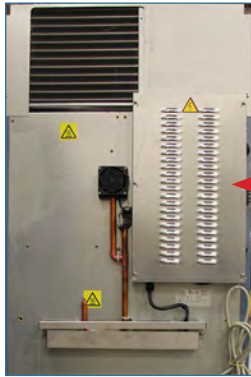

Electrical panel

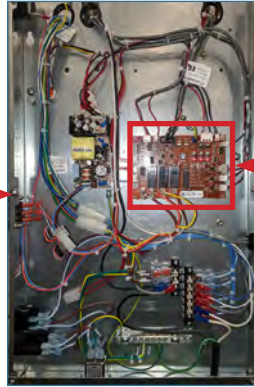

Control board



Manual defrost momentary button.

Notes

- For consistent freezer operation, units are shipped with three preprogrammed defrost cycles per day.
- Manual defrost events can be initiated any time of day.
- A defrost cycle lasts 15 minutes.
- AC power must be restored within 15 minutes to prevent termination of manual defrost event.
- Defrost events must be at least one hour apart.
- Contact Helmer Technical support for more information regarding changing defrost frequency or duration.



Some surfaces on the back of the freezer may be hot. Take care when accessing the back of the unit.

Manual Defrost Events

1. Switch the AC power switch OFF. Turn the Alarm key switch OFF.
2. Using a #2 Phillips screwdriver, loosen the six screws securing the access panel to the electrical compartment.
3. Slide the panel upward to disengage the screws from the keyhole openings in the panel and remove.
4. On the control board, locate the manual defrost push button and push to initiate.
5. Reinstall the access panel by engaging the six screws along the outside of the electrical compartment with the keyhole openings in the panel and slide down.
6. Tighten all screws using a # 2 Phillips screwdriver.
7. Switch the AC power switch ON. Turn the Alarm key switch ON.

9.5 Prepare for Monitoring

The monitoring system back-up battery is installed on the unit but not connected. Connect the battery and switch the audible alarm key switch to ON to provide monitoring system with back-up power and alarm capability in the event of AC power failure. If included, switch the Access Control back-up battery ON to provide the optional Access Control system with back-up power in the event of an AC power failure.

Temperature Probes

Notes

- Temperature probes are fragile; handle with care.
- Failure to fill the probe bottle or keep the probe bottle filled to the appropriate level may cause the chamber temperature to display higher or lower than the actual temperature.
- Remote probes may also be introduced through the existing port and immersed in the existing probe bottle.
- External probes should not be routed into the chamber through the door opening as this may cause issues with the door seal.

A probe bottle and container of propylene glycol have been provided with this unit. The propylene glycol is mixed with water to create a solution which, when placed in the probe bottle, simulates the product stored in the freezer. The product simulation solution temperature reflects the product's temperature during normal operation.

The probe bottle should contain 4 oz. (120 mL) of product simulation solution (1:1 ratio of water to propylene glycol).



Probe bottle with probe.

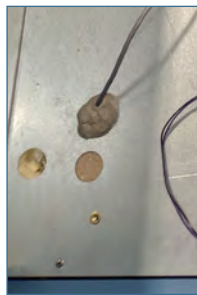

Top access port.

Fill Probe Bottle

1. Remove the probe(s) from the bottle and remove the bottle from the bracket.
2. Remove the cap and fill with 4 oz. (120 mL) of product simulation solution.
3. Replace and secure the cap and place the bottle in the bracket.
4. Replace the probe(s), immersing at least 2" (50 mm) in solution.

Install Additional Probe Through Top Access Port

1. Peel back putty to expose the port.
2. Insert the probe through the port into the chamber.
3. Insert the probe into the bottle.
4. Replace putty, ensuring a tight seal.

Chart Recorder (if included)

Note

- If chart recorder has been operating on back-up battery power, the battery should be replaced to ensure the back-up source has proper charge.
- For complete information, refer to the Temperature Chart Recorder Operation and Service Manual.

The chart recorder has a back-up battery system, enabling a period of continuous operation if power is lost. Battery life varies by manufacturer as well as voltage level remaining. Providing full power is available, back-up power for the temperature chart recorder is available for up to 14 hours.

Prior to use:

Route the chart recorder probe through the top access port and place in the bottle with the primary monitor probe.

Set up and Operation

Access the chart recorder by pulling the door open.



 **Install Battery**

Connect the leads to the battery to provide back-up power to the chart recorder.

 **Install / Replace Chart Paper**

 **Note**

- For accurate temperature reading, ensure the current time is aligned with the time line groove when the chart knob is fully tightened.
- Contact Helmer Technical Service or your distributor to reorder chart paper.



*Chart recorder stylus
and time line groove*

1. Press and hold the **C** button. When the stylus begins to move left, release the button. The LED flashes.
2. When the stylus stops moving, remove the chart knob then move the knob up and away.
3. Place chart paper on the chart recorder.
4. Gently lift the stylus and rotate the paper so the current time line corresponds to the time line groove.
5. Hold the chart paper in place while making sure the chart knob is fully tightened. *(Failure to fully tighten the knob can result in paper slipping and losing time.)*
6. Press and hold the **C** button. When the stylus begins to move right, release the button.
7. Confirm the stylus is marking on the paper and stops at the correct temperature.
8. Calibrate the chart recorder to match the primary temperature if needed and close the recorder door.

External Monitoring Devices

The remote alarm interface is a relay switch with three terminals:

- ◆ Common (COM)
- ◆ Normally Open (NO)
- ◆ Normally Closed (NC)

Terminals are dry contacts and do not supply voltage. Interface circuit is either normally open or normally closed, depending on terminals used.

Requirements for your alarm system determine which alarm wires must connect to terminals.



- The interface on the remote alarm monitoring system is intended for connection to the end user's central alarm system(s) using normally-open or normally-closed dry contacts.
- If an external power supply exceeding 33 V (RMS) or 30V (DC) is connected to the remote alarm monitoring system's circuit, the remote alarm will not function properly and may cause damage to the control board or result in injury to the user.

The terminals on the remote alarm interface have the following maximum load capacity:

- ◆ 115V or 230V: 1 A at 33V (AC) RMS or 30V (DC)

Connect to Remote Alarm Interface

1. On the back of the freezer, locate the remote alarm terminals.
2. Connect the remote alarm wires to the appropriate terminals, according to the requirements for your alarm system.
3. Use a cable tie to relieve strain on the alarm wires (as necessary).

9.6 Configure Storage

Notes

- Before moving storage components, protect stored items in the freezer from extended exposure to adverse temperature.
- Before moving drawers or shelves, ensure they are completely empty for safe lifting.
- Maximum drawer or shelf load is 100 lbs (46 kg).

Product Loading Guidelines

Note

Products stacked against the back wall may obstruct air flow and affect performance of the unit.

When loading your freezer, take care to observe the following guidelines:

- ◆ Never load the freezer beyond capacity.
- ◆ Always store items within shelves or drawers.
- ◆ Temperature uniformity is maintained by air circulation, which could be impeded if the unit is overfilled, particularly at the top or back. Ensure a minimum of 2" (50 mm) clearance is provided below the fan.

Drawers

Remove Drawer

1. Pull the drawer out until it stops.
2. Lift the front of the drawer off the front rollers on the slide.
3. With the front of the drawer slightly lifted, pull the drawer all the way forward. The rear drawer rollers should be touching the front slide rollers.
4. Lift the drawer to free from the slides.

Install Drawer

1. Align the rear rollers on the drawer with the opening just behind the front slide rollers.
2. Place the rear drawer rollers on the slides and gently push the drawer into the chamber until it stops.
3. Pull the drawer out until it stops to check for smooth operation.

Move Drawer Slides

1. Using a screwdriver, remove the bracket retainers.
2. Tap the brackets upward to disengage from standards.
3. Remove the slides from the standards.
4. Insert the slides into the standard at the appropriate height.
5. Tap the brackets downward to engage with standards.
6. Using a screwdriver, install the bracket retainers.

Shelves

Remove Shelf

1. With one hand, lift the front edge of the shelf from the front brackets approximately 8 inches.
2. With the other hand, reach under the shelf and bump the rear edge of the shelf upward to disengage rear brackets.

Install Shelf

1. Insert the shelf into chamber, placing it on the rear brackets and with the front edge of the shelf angled upward approximately 8 inches.
2. Lower the front edge and gently bump the rear edge of the shelf downward to engage with brackets.
3. Pulling the shelf forward gently; the shelf should not disengage from the rear brackets.

Move Shelf Brackets

1. Using a screwdriver, remove the bracket retainers.
2. Tap the brackets upward to disengage from standards.
3. Remove the brackets from the standards.
4. Insert the brackets into the standard at the appropriate height.
5. Tap the brackets downward to engage with standards.
6. Using a screwdriver, install the bracket retainers.

10 Controls

Horizon Series models are equipped with a monitor and optional control system which allows users to view and change current settings.

10.1 Monitor and Control Interface

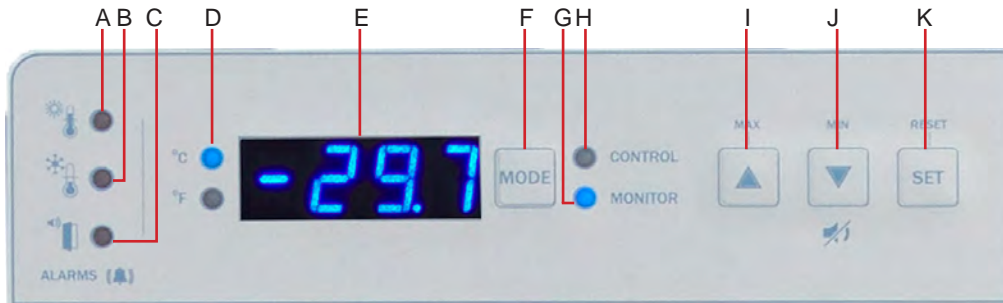

Table 10. Monitor and Control Indications

Label	Description	Function
A	HIGH TEMP lamp	Indicates when the freezer is in a high temperature alarm condition. Also indicates the high alarm temperature setpoint is being changed.
B	LOW TEMP lamp	Indicates when the freezer is in a low temperature alarm condition. Also indicates the low alarm temperature setpoint is being changed.
C	DOOR OPEN lamp	Indicates when freezer door is open.
D	Temperature Unit Indicator	Indicates temperature reading is in °C or °F.
E	Display	Displays real-time temperature information, setpoints, and alarms.
F	MODE button	Allows selection of CONTROL or MONITOR mode.
G	MONITOR lamp	Indicates when the display is showing temperature readings from the monitor probe. Also indicates when alarm setpoints are being changed.
H	CONTROL lamp	Indicates when the reading from the control probe is displayed.
I	UP ARROW button	Increases a temperature setting.
J	DOWN ARROW / MUTE ALARM button	Decreases a temperature setting. Also mutes the audible alarm for 5 minutes.
K	SET button	Allows settings to be selected, prior to changing settings.

Note

The Alarm Disable key switch disables all audible alarms. This switch does not affect alarm lamps or signals sent through the remote alarm interface.

Display Minimum and Maximum Monitor Temperature Recordings

The minimum and maximum recording feature allows the user to view a minimum temperature occurrence and a maximum temperature occurrence within a given period of time. The timer provides a time reference in which those temperatures occurred.

View *Minimum* Temperature Recording

- ◆ Press and hold the **Down Arrow** button for one second and listen for a single beep. 
- ◆ The display will alternate between **LO** and a valid temperature value five times followed by a single beep to indicate exit back to the temperature display.



View *Maximum* Temperature Recording

- ◆ Press and hold the **Up Arrow** button for one second and listen for a single beep. 
- ◆ The display will alternate between **HI** and a valid temperature value five times followed by a single beep to indicate exit back to the temperature display.



View Recorded Temperature Timer

Notes

- The timer denotes the period of time elapsed. It does not display the time at which a minimum or maximum temperature occurred.
- The maximum period of time the timer can record is 99:59 (99 hours and 59 minutes).

- ◆ Press and hold either the **Up** or **Down Arrow** button for one second.  or 
- ◆ While the display is flashing the **HI** or **LO** value, press and hold the **SET** button for one second.
- ◆ The display will alternate five times between **CLr** and a value representing the number of hours and minutes elapsed since the last recording (example: 12:47 would represent 12 hours and 47 minutes). A single beep will follow to indicate exit back to the temperature display.

Clear Minimum and Maximum Temperature Recordings

- ◆ Press and hold either the **Up** or **Down Arrow** button for one second.  or 
- ◆ While the display is flashing the **HI** or **LO** value, press and hold the **SET** button for one second and listen for a single beep.
- ◆ While the display is flashing the elapsed time since last reset, press and hold the **SET** button for two seconds. **CLr** will be displayed followed by a series of three beeps to indicate exit back to the temperature display.

Notes

The minimum and maximum temperature and timer will reset when:

- the unit is powered off and battery back-up is not engaged, or
- after 99 hours and 59 minutes have elapsed.

10.2 Alarm Reference

If an alarm condition is met, an alarm activates. Some alarms are visual only; others are visual and audible. Some alarms are sent through the remote alarm interface.

The table indicates if an alarm is audible (A), visual (V), or sent through the remote alarm interface (R).

Note

If the system is in Power Failure (PoFF) alarm, an Er05 error can be expected as a result of the absence of power to the compressor inverter.

Table 11. Alarm Indications

Alarm	Alarm Type	Visual Indicator
High Temperature (Primary Monitor Probe)	A, V, R	HIGH TEMP Lamp
Low Temperature (Primary Monitor Probe)	A, V, R	LOW TEMP Lamp
Display/Control Board Communication Error	A, V, R	Er04
Control Board to Compressor Inverter Error	A, V, R	Er05
Door Open (Time)	A, V, R	DOOR OPEN Lamp (<i>flashes after 3 minutes</i>)
Power Failure	A, V, R	PoFF
Probe Failure	Control (RTD1)	A, V, R
	Primary Monitor (RTD2)	A, V, R
	Evaporator (RTD3)	A, V, R
No Battery	V	Er06 (<i>units with firmware version v1.25 and prior</i>)
		bAtt (<i>units with firmware version v1.26</i>)
Configuration Error	A, V, R	Er07

10.3 Settings

Temperature Setpoint

The factory default temperature setpoint for the freezer is -30.0 °C. For locations outside the U.S. and Canada, the factory default temperature setpoint for plasma freezers is -35.0 °C. This can be changed if your organization requires a chamber temperature other than the default setting.

Change Setpoint:

Note

The current temperature setpoint is typically higher than the chamber temperature.

1. Press and release **MODE** to change to Control mode. The CONTROL lamp will illuminate.
2. Press and hold **SET** to display the current temperature setpoint.
3. Hold **SET** and press the **Up** or **Down Arrow** as necessary to set the desired setpoint value.
4. Release the **SET** button. The setpoint is changed.
5. Press and release **MODE** to return to Monitor mode. The MONITOR lamp will illuminate.

Temperature Settings

Temperature settings are factory pre-set. Settings can be viewed and changed through the Monitor and Control interface.

Table 12. Parameters, Indicators and Settings

Parameter	Visual Indicator	Range	Default	
Celsius or Fahrenheit	°C Lamp or °F Lamp	.C, .F	.C	
High Temperature	MONITOR Lamp & HIGH Lamp	-40.0 to 25.0 (°C); -40 to 77 (°F)	-20.0 °C	-25.0 °C*
Low Temperature	MONITOR Lamp & LOW Lamp	-40.0 to 25.0 (°C); -40 to 77 (°F)	-35.0 °C	-40.0 °C*
Monitor Offset	MONITOR Lamp only	-10.0 to 10.0 (°C); -18 to 18 (°F)	Varies	
Control Offset	CONTROL Lamp only	-10.0 to 10.0 (°C); -18 to 18 (°F)	Varies	
Evaporator Defrost Offset	MONITOR lamp & CONTROL lamp	-10.0 to 10.0 (°C); -18 to 18 (°F)	Varies	
Upper Rail Limit	CONTROL Lamp and HIGH Lamp	0.1 to 10.0 (°C); 1 to 18 (°F)	0.7 °C	
Lower Rail Limit	CONTROL Lamp and LOW Lamp	-0.1 to -10.0 (°C); -1 to -18 (°F)	-0.7 °C	

* Factory default setting for plasma freezers for locations outside the U.S. and Canada.

View Settings and Offset Values

1. Press and hold the **Up** and **Down Arrows** simultaneously for three seconds to enter program mode.
2. The LED Display will show .C or .F to indicate Celsius or Fahrenheit.
3. Press and release **MODE** to scroll through the parameters and view settings.
4. Hold the **Up** and **Down Arrows** simultaneously for three seconds to exit program mode.
5. The LED Display will show the current monitor temperature.

Temperature Units

Note

If temperature units are changed, the temperature setpoints, offsets and alarm settings must be recalibrated.

Select Temperature Units

1. Press and hold the **Up** and **Down Arrows** simultaneously for three seconds to enter program mode.
2. The LED Display will show .C or .F to indicate Celsius or Fahrenheit.
3. Press and hold the **SET** button while pressing the **Up** or **Down Arrow** to select the desired temperature unit parameter.
4. Release the **SET** button. The new setting is saved.
5. Press and hold the **Up** and **Down Arrows** simultaneously for three seconds to exit program mode.

Alarm Settings

The high and low temperature alarm settings may be changed by the operator. Temperature alarm setpoints specify the temperature at which an alarm activates. The setpoint for temperature alarms may be changed.

High Temperature Alarm

Change the Alarm Setpoint

1. Press and hold the **Up** and **Down Arrows** simultaneously for three seconds to enter program mode.
2. The LED Display will show .C or .F to indicate Celsius or Fahrenheit.
3. Press **MODE** until the HIGH TEMP and MONITOR lamps flash.
4. Hold **SET**, then press the **Up** or **Down Arrow** to change the setpoint.
5. Release the **SET** button. The new setting is saved.
6. Press and hold the **Up** and **Down Arrows** simultaneously for three seconds to exit program mode.

Low Temperature Alarm

Change the Alarm Setpoint

1. Press and hold the **Up** and **Down Arrows** simultaneously for three seconds to enter program mode.
2. The LED Display will show .C or .F to indicate Celsius or Fahrenheit.
3. Press **MODE** until LOW TEMP and MONITOR lamps flash.
4. Hold **SET**, then press the **Up** or **Down Arrow** to change the setpoint.
5. Release the **SET** button. The new setting is saved.
6. Press and hold the **Up** and **Down Arrows** simultaneously for three seconds to exit program mode.

Primary Monitor Probe

Verify the primary monitor probe is reading the chamber temperature correctly by comparing primary monitor probe readings to the temperature measured by a calibrated reference thermometer. If the primary monitor probe is not reading correctly, change the monitor offset value displayed.

Notes

- Ensure the product simulation bottle is full of solution.
- The probe in the bottle is connected to the monitoring system and represents product storage temperature. This probe does not affect the temperature control.

Calibrate Primary Monitor Probe

1. Remove the primary monitor probe from the probe bottle.
2. Unscrew the cap from the bottle.
3. Attach a calibrated independent reference thermometer traceable per national standards to the primary monitor probe, and place them in the bottle. The probe and thermometer should be immersed at least 2" (50 mm).
4. Note the temperature on the calibrated reference thermometer and compare to the chamber temperature displayed on the monitor.
5. Adjust the monitor offset value higher or lower to reflect the difference between the chamber temperature displayed on the monitor and the temperature reading from the calibrated reference thermometer.
6. Remove the reference thermometer from the probe.
7. Replace the bottle cap, ensuring a tight fit.
8. Place the probe in the bottle, immersing at least 2" (50 mm).

Enter the New Offset Value:

1. Press and hold the **Up** and **Down Arrows** simultaneously for three seconds to enter program mode.
2. The display will show .C or .F to indicate Celsius or Fahrenheit.
3. Press **MODE** until the MONITOR lamp flashes.
4. Hold **SET**, then press the **Up** or **Down Arrow** to change the monitor offset.
5. Release the **SET** button. The new setting is saved.
6. Press and hold the **Up** and **Down Arrows** simultaneously for three seconds to exit program mode.

Control Sensor

The temperature controller senses unit cooler temperature through the control probe in the unit cooler. The unit cooler temperature typically varies from the chamber temperature, so an offset value is used by the control system to compensate for the difference.

The temperature controller adjusts chamber temperature around the freezer setpoint.

Determine Control Sensor Offset:

Notes

- Control Sensor Offset is factory-preset and changing this value is not recommended. Contact Helmer Technical Service for questions regarding the Control Sensor Offset.

- View and record the Freezer Setpoint. (Reference Section 10.3)
- Allow the unit to run with a calibrated monitor temperature for several compressor cycles, and record the average monitor temperature. *(If the monitor temperature remains close to the freezer setpoint no further action is needed.)*
- View and record the current Control Offset value.
- Subtract the Freezer Setpoint from the average monitor temperature and record the difference.
- Add the current Control Offset value to the recorded difference determined in the previous step to establish the new Control Offset value.

Example 1	Example 2
Freezer Setpoint is -30.0	Freezer Setpoint is -30.0
Average monitor temperature is -29.2	Average monitor temperature is -31.2
Current Control Offset is 0.3	Current Control Offset is 0.3
Subtract: $-29.2 - (-30.0) = 0.8$ (difference between average temperature and setpoint)	Subtract: $-31.2 - (-30.0) = -1.2$ (difference between average temperature and setpoint)
Add $0.3 + 0.8 = 1.1$; new Control Offset value	Add $0.3 + (-1.2) = -0.9$; new Control Offset value

Enter the New Offset Value:

- Press and hold the **Up** and **Down Arrows** simultaneously for three seconds to enter program mode.
- The display will show .C or .F to indicate Celsius or Fahrenheit.
- Press **MODE** until only the CONTROL lamp flashes.
- Hold **SET**, then press the **Up** or **Down Arrow** to change the setpoint.
- Release the **SET** button. The new setting is saved.
- Press and hold the **Up** and **Down Arrows** simultaneously for three seconds to exit program mode.

Upper Rail

The Upper Rail Limit is the maximum control temperature at which the compressor will turn on.

Lower Rail

The Lower Rail Limit is the minimum control temperature at which the compressor will turn off.

NOTE

The Upper Rail and Lower Rail values are factory-preset and should not be changed unless directed by Helmer Technical Service.

Non-Configurable Alarms

The Power Failure and Door Open alarms indicate operational conditions which may require the attention of the operator or a qualified service technician. The Power Failure alarm will activate immediately upon loss of power. The Door Open alarm will activate once the door has remained open for approximately three minutes. These settings are factory-preset and may not be changed.

11 Maintenance

Maintenance tasks should be completed according to the schedule below.

Notes

- The preventive maintenance schedule provides recommended minimum requirements. Regulations or physical conditions at your organization may require maintenance items be performed more frequently, or only by designated service personnel.
- Before performing maintenance, protect items in freezer from extended exposure to adverse temperature.
- Allow freezer temperature to stabilize at setpoint after performing service or after extended door opening.

Table 13. Horizon Series Preventive Maintenance Schedule

Task	Frequency			
	1 year	2 years	5 years	As Needed
Test the high temperature <i>(over maximum temperature limit)</i> alarm <i>(as required by your organization's protocols)</i> .				✓
Test the power failure alarm <i>(as required by your organization's protocols)</i> .				✓
Test the door alarm <i>(as required by your organization's protocols)</i> .				✓
Verify the temperature calibration on the monitor and change it if necessary.	✓			
Replace monitoring system back-up battery.	✓			
Examine probe bottle and clean or replace if necessary.	✓			
Check the solution level in the probe bottle. Refill or replace if necessary.				✓
Clean the door gaskets, interior, and exterior of the freezer.				✓
Clean the condenser grill.				✓
Replace optional Access Control back-up battery.		✓		
Models with chart recorders				✓
Check the back-up battery for the chart recorder after an extended power failure and change it if necessary, or change the battery if it has been in service for one year. Refer to the Temperature Chart Recorder Operation and Service Manual.				✓

NOTICE

- Clean the condenser grill regularly. Dust accumulation on the condenser coil will vary based on the environment. Some environments require quarterly cleaning.
- Some equipment surfaces may be sharp. Take care when cleaning to avoid injury.

Note

During a power failure the monitoring system back-up battery provides power to the monitoring system and power failure alarm. If the back-up battery is not functioning, the power failure alarm will not be activated and the battery should be replaced.

11.1 Alarm Tests

Test alarms to ensure they are working correctly. The freezer has alarms for chamber temperature, power failure, and door open (time).

Chamber Temperature Alarm Test

NOTICE

- Before testing alarms, protect items stored in the unit from extended exposure to adverse temperature.
- Temperature probes are fragile; handle with care.

Test the High Alarm:

1. Identify the setting for high alarm setpoint.
2. Place the glass of product simulation solution in the freezer.
3. When the product simulation solution has stabilized at the chamber temperature, remove the solution from the freezer.
4. Remove the monitor probe from the probe bottle and insert into the product simulation solution.
5. Observe the temperature on the monitoring system display at which the high temperature alarm sounds.
6. Compare the temperature at which the alarm sounds to the high alarm setpoint.
7. Remove the probe from the product simulation solution.
8. Place the monitor probe in the probe bottle, immersing it at least 2" (50 mm).

Power Failure Alarm Test

Note

During a power failure, the back-up battery should continue to provide power to the monitoring system.

1. Switch the AC power switch OFF. The audible power failure alarm will activate by displaying "PoFF" (power off) and an audible tone can be heard approximately every 30 seconds.
2. Switch the AC power switch ON. The audible power failure alarm will cease and "PoFF" will clear from the display.

Door Open Alarm Test

Note

The Door Open alarm is factory-set to three minutes and cannot be changed.

1. Open the freezer door and note the time.
2. After three minutes, the audible alarm will activate and the DOOR ALARM lamp will flash.
3. Close the freezer door. The audible door open alarm will cease and the DOOR ALARM lamp will stop flashing.

11.2 Test and Replace Back-up Batteries

Check Monitoring System Battery

The monitoring system does not indicate the charge level of the battery. Regularly test the battery and replace the battery if the test fails or if the battery has been in use for one year.

Note

Use only a 9V lithium battery.

Test the Battery:

1. Switch the AC power switch OFF.
2. The display should continue to display information.
3. If the display is blank, replace the battery.
4. Switch the AC power switch ON.

Check Optional Access Control System Battery

During an AC power failure, the Access Control back-up battery provides back-up power to the magnetic Access Control lock. Test the Access Control back-up battery to ensure it is working properly.

Test the Battery:

1. Ensure the Access Control back-up battery key switch is switched ON.
2. Switch the AC power switch OFF.
3. Verify the “PoFF” (power failure) message is displayed.
4. Attempt to open the cabinet door, if the door remains locked, the battery is functional. If the door does not remain locked, replace the battery.
5. Switch the AC power switch ON.

Remove and Replace Battery



Take care not to short the battery terminals to the bracket or to each other when removing or attaching terminal connectors, bracket or bracket screws.

1. Switch the battery back-up switch OFF; switch the AC power switch OFF; disconnect the AC power cord from the power receptacle.
2. Using a #2 Phillips screwdriver, remove the four screws securing the access panel to the top cover to the unit. Set the panel and screws aside.
3. Locate the 12V battery and remove the wires from the terminals.
4. Using a #2 Phillips screwdriver remove the screw from the mounting bracket, and remove the old battery.
5. Place the new battery in the same location as the one removed.
6. Install the bracket over the battery and secure with the screw.
7. Reconnect the wires to the correct terminals.
8. Replace the access panel and secure with four screws using a #2 Phillips screwdriver.
9. Reconnect the AC power cord; switch the AC power switch to ON; switch the battery back-up switch to ON.

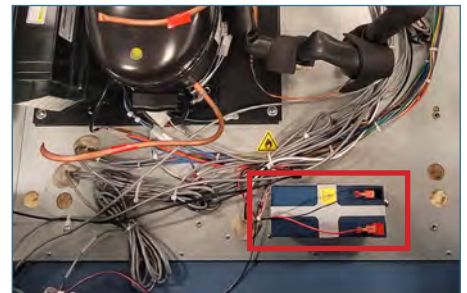

Chart Recorder Back-up Battery (if included)

Refer to the Temperature Chart Recorder Operation and Service Manual.

11.3 Check Probe Bottle

Remove the probe bottle from the bracket and inspect for cracks. Replace the bottle if necessary.

Ensure the probe bottle has approximately 4 oz (120 mL) of product simulation solution (1:1 ratio of water to propylene glycol). The propylene glycol is mixed with water to create a solution which simulates the product stored in the freezer. The product simulation solution temperature reflects the product's temperature during normal operation. Failure to fill the bottle may prevent the chamber temperature from stabilizing at the temperature setpoint. The probe should be immersed at least 2" (50 mm).

11.4 Clean the Freezer

Cabinet Exterior

Clean exterior surfaces with a soft cotton cloth and non-abrasive liquid cleaner.

Cabinet Interior

Clean painted surfaces with mild detergent. Clean stainless steel surfaces with a general-purpose laboratory cleaner suitable for stainless steel.

Condenser Grill



Disconnect the freezer from AC power when cleaning condenser grill.

NOTICE

Some equipment surfaces may be sharp. Take care when cleaning to avoid injury.

If the freezer is located in an environment where it is exposed to excessive lint or dust, the condenser grill may require cleaning more frequently than stated in the preventive maintenance schedule.

Clean the condenser grill using a soft brush and a vacuum cleaner.

Door Gaskets

Clean with a soft cloth and mild soap and water solution.

Probe Bottle



Clean and Refill Probe Bottle

1. Remove all probes from the bottle.
2. Remove the bottle from the bracket and empty any remaining solution.
3. Clean the bottle with a 1:9 ratio of bleach to water solution or a company approved cleaner/disinfectant.
4. Refill the bottle with 4 oz. (120 mL) of product simulation solution (1:1 ratio of water to propylene glycol).
5. Cap the bottle tightly to minimize evaporation.
6. Place the bottle in the bracket.
7. Replace the probe(s), immersing at least 2" (50 mm).

12 Service

12.1 Refrigerant



Risk of fire or explosion. Flammable refrigerant used. To be repaired only by trained service personnel. DO NOT puncture refrigerant tubing.

NOTICE

- Review all safety instructions prior to recharging refrigerant.
- Maintenance should only be performed by trained refrigeration technicians familiar with hydrocarbon refrigerants.

Table 14. Refrigerant Charge

Refrigerant	Initial Charge
R290	4.6 oz. (130.4 g +/- 1 g)

12.2 Remove / Replace Unit Cooler Cover

The unit cooler cover must be removed when servicing the control probe, defrost probe, heating pad, fan motor(s) or coil.

NOTICE

- If the unit cooler cover is not removed as detailed in this procedure the drain port may be damaged. Improper drainage may result in excessive icing and the freezer's inability to maintain temperature.
- Temperature probes are fragile; handle with care.

Note

The Cold-Shield™ (if installed) must be taken out prior to removing the unit cooler cover.

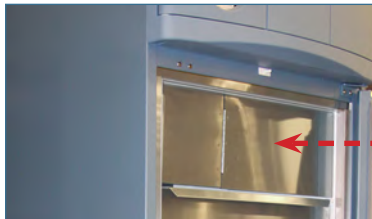

Cold-Shield

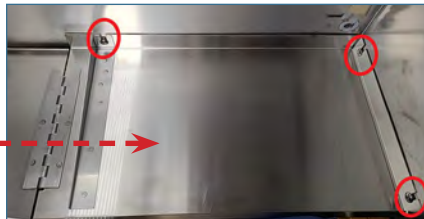

Cold-Shield (rear view)

Remove Cold-Shield™ (if installed)

1. Remove the top drawer from the cabinet (refer to Section 2.5).
2. From the back side of the Cold-Shield panel, loosen the three screws securing the Cold-Shield to the cabinet using a #2 Phillips screwdriver.
3. Slide the panel forward to remove.

Install Cold Shield™ (if installed)

1. Reinstall Cold-Shield by aligning the slots in the panel with the screws in the cabinet and sliding inward.
2. From the back side of the panel, tighten the three screws securing the Cold-Shield to the cabinet using a #2 Phillips screwdriver.
3. Reinstall the top drawer in the cabinet.



Label	Description
A	Unit cooler cover
B	Drain port

Unit cooler cover and drain port

Remove Unit Cooler Cover

1. Switch the AC power switch OFF. Switch the back-up battery switch OFF.

Steps 2 - 5 apply to 20 cu ft models only. All other models proceed to Step 6.

2. Carefully remove the probe from the probe bottle and unwind the probe wiring from the cleat. Allow the probe to hang along the side of the cabinet.
3. Remove the probe bottle from the bracket and set aside.
4. Loosen the two screws securing the probe bottle bracket using a #2 Phillips screwdriver. Remove the bracket and set aside.
5. Using a #2 Phillips screwdriver, remove the two screws securing the cleat from the side of the chamber. Set the cleat and screws aside.
6. Hold the unit cooler cover in place to prevent dropping. Using an 8mm socket driver, remove the four screws securing the unit cooler cover.
7. Carefully lower the unit cooler cover to avoid damage to the fan wiring.
8. Disconnect the fan motor and heating pad wire connections.
9. Once the cover is dropped down far enough to clear the rear of the evaporator, lift and pull the cover forward to unhook the drain tube connections from the cover.

Install Unit Cooler Cover

1. Insert the drain tube on the cover into the copper drain port in the back of the unit with the drain tube heater sticking through.
2. Reconnect the fan motor and heating pad wire connections and verify they are routed correctly.
3. Lift the unit cooler cover into place. The front edge of the cover should be behind the unit cooler case.
4. Secure the unit cooler cover with the four screws using an 8 mm socket driver.
5. Inside the unit, adjust the copper tubing onto the drain on the cover to make to ensure proper condensate drainage.
6. Reinstall the top drawer or shelf if previously removed.
7. Reinstall cleat, water bottle bracket and water bottle if previously removed.
8. Switch the AC power switch ON. Switch the back-up battery switch ON.
9. Touch **Mute** to disable the high temperature alarm while freezer reaches operating temperature.

13 Troubleshooting

NOTICE

Review all safety instructions prior to troubleshooting.

13.1 Access System Problems

Problem	Possible Cause	Action
Door does not lock	Lock mechanism is damaged.	Inspect lock/latch, Replace if necessary.
Door does not lock (Magnetic Access Control Option)	Magnetic door lock is not aligned with the strike plate.	Align lock/door to the match strike plate.
	Magnetic lock is not receiving power.	Trace voltage to the lock using the schematic, replace lock if needed.

13.2 Alarm Activation Problems

Problem	Possible Cause	Action
Battery alarms (Er06)	The 9V battery is not installed.	Install 9V battery.
	The battery is low due to a power failure.	Allow the battery to recharge.
	Faulty battery or wiring connection.	Check wiring and replace battery if needed.
Probe failure alarms (Er01 - Control Probe; Er02 - Monitor Probe; Er03 - Evaporator Defrost Probe)	Faulty probe or wiring connection.	Check corresponding probe connection. Test resistance of probe (86 Ω to 110 Ω) Replace probe if needed.
Power failure alarm (PoFF)	Power was interrupted to freezer.	Restore facility power.
	Power switch is in the off "o" position.	Turn power switch to the on "-" position.
	Power cord is loose.	Check both ends of the power cord at the wall outlet and the freezer.
	GFI/GFCI Outlet has tripped.	Move to standard outlet. Helmer does not recommend operating this unit on a GFI outlet.
Inverter Error (Er05)	Power was lost to the freezer.	See Power Failure alarm.
	Loose wiring connection.	Check wiring between control board and inverter.
Door alarm	Door is open.	Close door.
	Faulty door switch or wiring connections.	Check wiring and continuity of switch contacts. Replace switch if needed.
Alarm is active but there is no audible alarm.	Key switch is in the OFF position.	Turn key to ON position.

13.3 Chamber Temperature Problems

Problem	Possible Cause	Action
Temperature display does not match actual temperature.	Display temperature needs to be calibrated.	Follow temperature calibration process.
	Probe bottle is empty, or probe is out of bottle.	Check level of solution in bottle and or insert probe into bottle.
Chamber temperature is too high/low.	Probe bottle is empty, or probe is out of bottle.	Check level of solution in bottle and or insert probe into bottle.
	Display temperature needs to be calibrated.	Follow temperature calibration process.
	Door was recently opened or opened for an extended time.	Close door and allow temperature to stabilize.
	Condenser coil is dirty.	Clean the condenser coil regularly, removing all dust build up.
	Lack of air flow around unit/high ambient condition.	Check for proper spacing around unit, any foreign objects blocking airflow, and that ambient temperature is within specification.
	Lack of air flow inside of chamber.	Verify product placement and move products if they block air flow around evaporator fan, or product hanging over the shelves against back wall.
	Temperature setpoint was adjusted.	Check temperature setpoint and temperature settings. Change to default settings or desired setpoint.
	Control probe is reading too high/low.	Check control offset setting, adjust if needed.
	Unit cooler fan motor (inside chamber) is not running.	Check voltage to the fan motor using schematic, replace fan motor if needed.
	Condenser fan motor (exterior) is not running.	Check voltage to the fan motor using schematic, replace fan motor if needed.
	Compressor is not running.	Check voltage to the compressor using schematic, replace compressor start components if needed.
	Ice build up in unit cooler.	See entry in Section 6.4

13.4 Condensation and Icing Problems

Problem	Possible Cause	Action
Excess frost/ice in chamber.	Some frost/ice within the freezer chamber is normal.	No action needed. Defrost the chamber if needed by turning the freezer off and leaving the door open until thawed, dry interior with cloth.
	Frequent or extended door openings.	Close the door and defrost chamber if needed.
	Chamber is not sealed.	Inspect door seal for damage, replace if needed. Check for wires routed through the door seal, reroute wires to the available though hole if needed. Check through holes and ensure they are sealed, reseal if needed.
	Automatic defrost cycle is not working.	Check defrost settings and test defrost cycle to determine issue.

14 Horizon Series Parts

Notes

- Before replacing parts, protect items in freezer from extended exposure to adverse temperature.
- Allow freezer temperature to stabilize at setpoint after replacing parts or after extended door opening.
- Circuit boards are sensitive to static electricity and can be damaged by electrostatic discharge. Use proper ESD precautions when handling the board.



Letter	Description	Part Number	Letter	Description	Part Number
A	Membrane	370225-1	H	Temperature chart recorder	400409-6
B	Display circuit board assembly	801016-1	I	Stylus arm and pen	400505-1
Not shown	Control/Monitor interface cable	402170-1	J	Chart paper (52 sheets)	220419
C	Primary monitor probe	801017-1	Not shown	Chart recorder back-up battery	120218
D	Probe bottle and propylene glycol kit	400922-2	Not shown	Chart recorder probe	400799-1
E	Caster - swivel with brake	220467	K	Latching door handle with lock	220426
F	Main Power switch	120478	Not shown	Strike plate	801174-1
G	Alarm ON/OFF key switch	120984	L	Access Control keypad	800007-1

Horizon Series

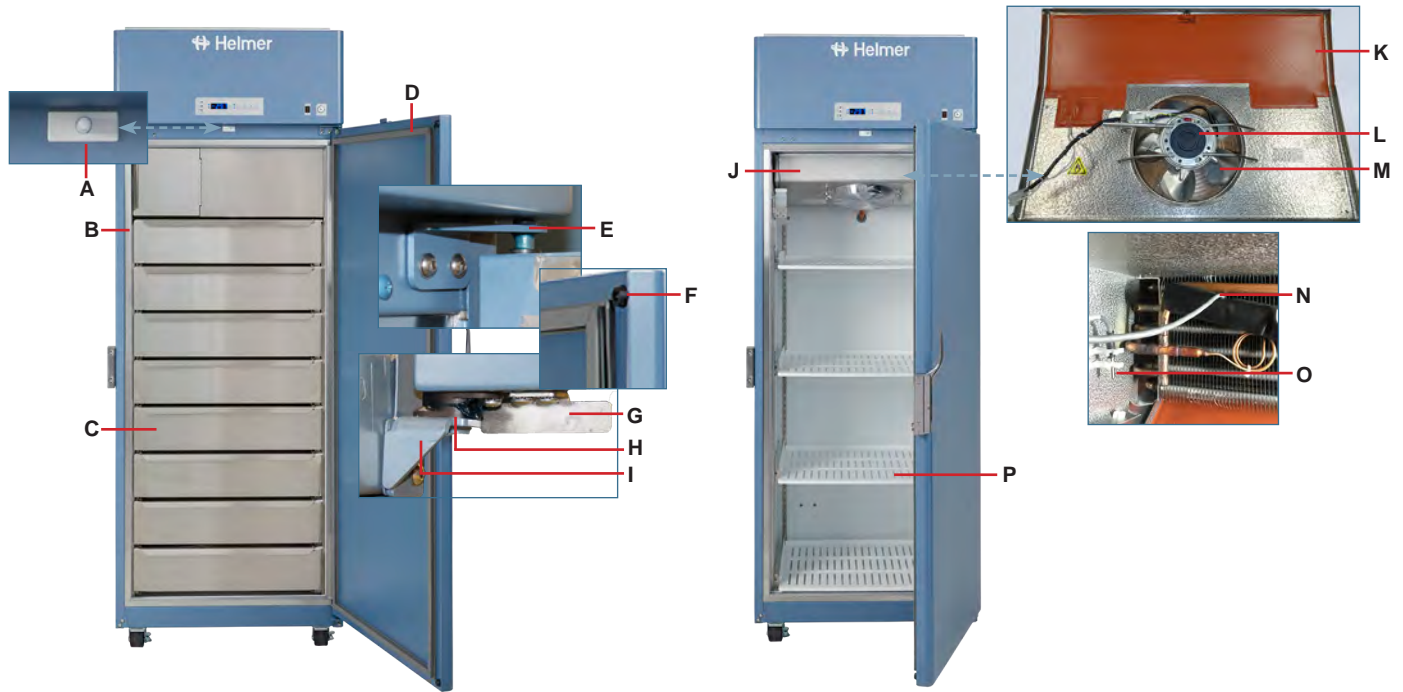

Letter	Description	Part Number	Model	Volts	Letter	Description	Part Number	Volts
A	Door switch	120380	-	-	H	Lower hinge cam	320742-1	-
B	Mullion heater (behind strike plates)	800883-1	-	115	I	Lower hinge bracket assembly * right assembly; ** left assembly	801142-1*	-
		800884-1	-	230			801172-1**	-
C	Drawer assembly (includes hardware and slides) * 20 cu ft units; ** 25 cu ft units	801131-1*	-	-	J	Evaporator assembly	801083-1	115
		801123-1**	-	-			801084-1	230
Not shown	Ventilated Drawer (white)	402322-1-069	120	-	K	Evaporator cover heater	801089-1	115
Not shown	Drawer Vent	801129-1	125	-			801090-1	230
D	Door gasket	801038-1	-	-	L	Evaporator fan motor	801114-1	-
E	Upper hinge bracket * right assembly; ** left assembly	801150-1*	-	-	M	Evaporator fan blade	220779	-
		801151-1**	-	-	N	Defrost probe	801081-1	-
Not shown	Upper/lower hinge bearing	220375	-	-	O	Control probe	801018-1	-
F	Door bumper	220441	-	-	P	Ventilated shelf * 20 cu ft units; ** 25 cu ft unit	801116-1*	-
G	Door stop	320763-1	-	-			801115-1**	-

Horizon Series

⚠ DANGER

Risk of fire or explosion. Flammable refrigerant used. To be repaired only by trained service personnel. DO NOT puncture refrigerant tubing.



- Disconnect unit from AC power before accessing the electrical compartment.

i Note

Circuit boards are sensitive to static electricity and can be damaged by electrostatic discharge. Use proper ESD precautions when handling the board.

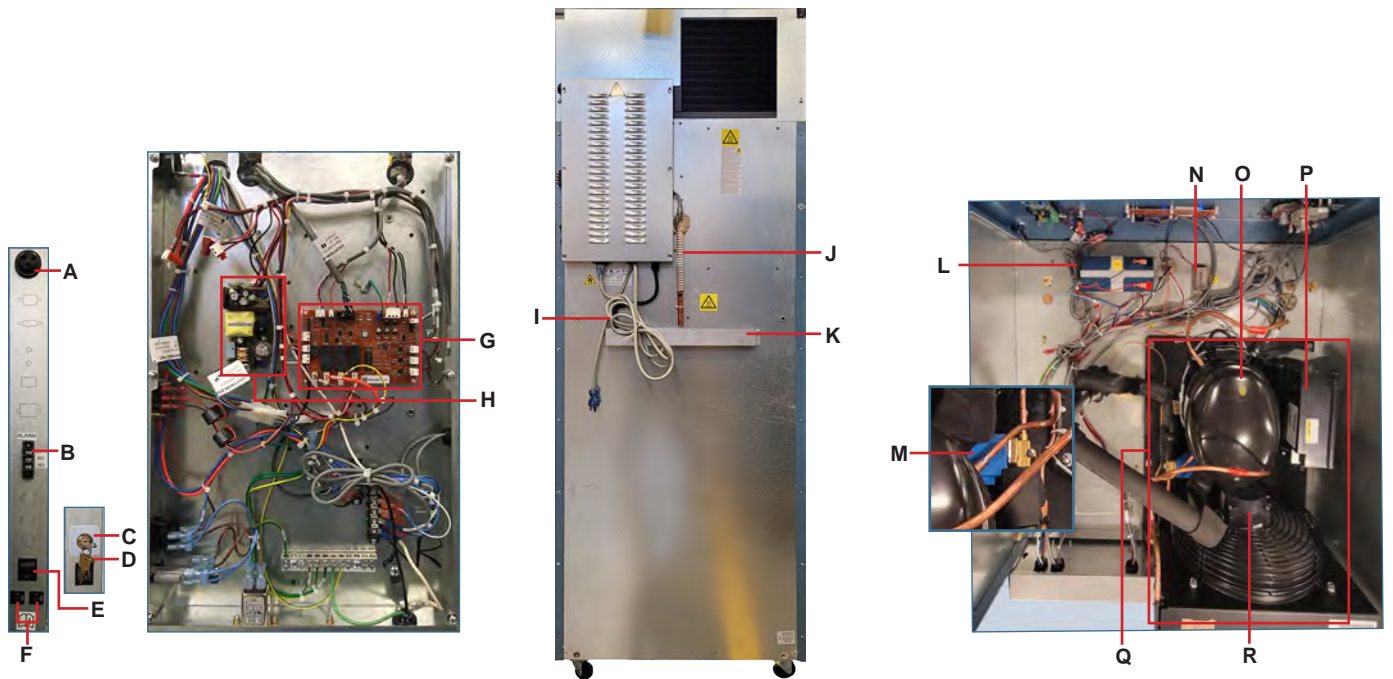

Horizon Series

Letter	Description	Part Number	Volts	Letter	Description	Part Number	Volts
A	Audible alarm	120160	-	K	Condensate evaporator tray assembly	801167-1	115
B	Remote alarm contacts	-	-			402326-2	230
C	Back-up battery key switch (with Access Control)	120754	-	L	Back-up battery (optional Access Control)	121018	-
D	Back-up battery key	120895	-	M	Defrost solenoid	801166-1	115
E	Main power switch	120478	-			801171-1	230
F	Circuit breakers (qty 2; 12A)	120287	-	N	Monitoring system back-up battery (9V Lithium)	-	-
G	Control board	801015-1	-	O	Compressor	-	-
H	Power supply board	120627	-	P	Compressor inverter	801087-1	115
I	Power cord	120630	115			801088-1	230
J	Drain line heater	801163-1	115	Q	Condensing Unit (includes condenser and compressor)	801085-1	115
		402302-1	230			801086-1	230
				R	Condenser fan motor	120985	-

15 Schematics

15.1 HBF and HLF Models

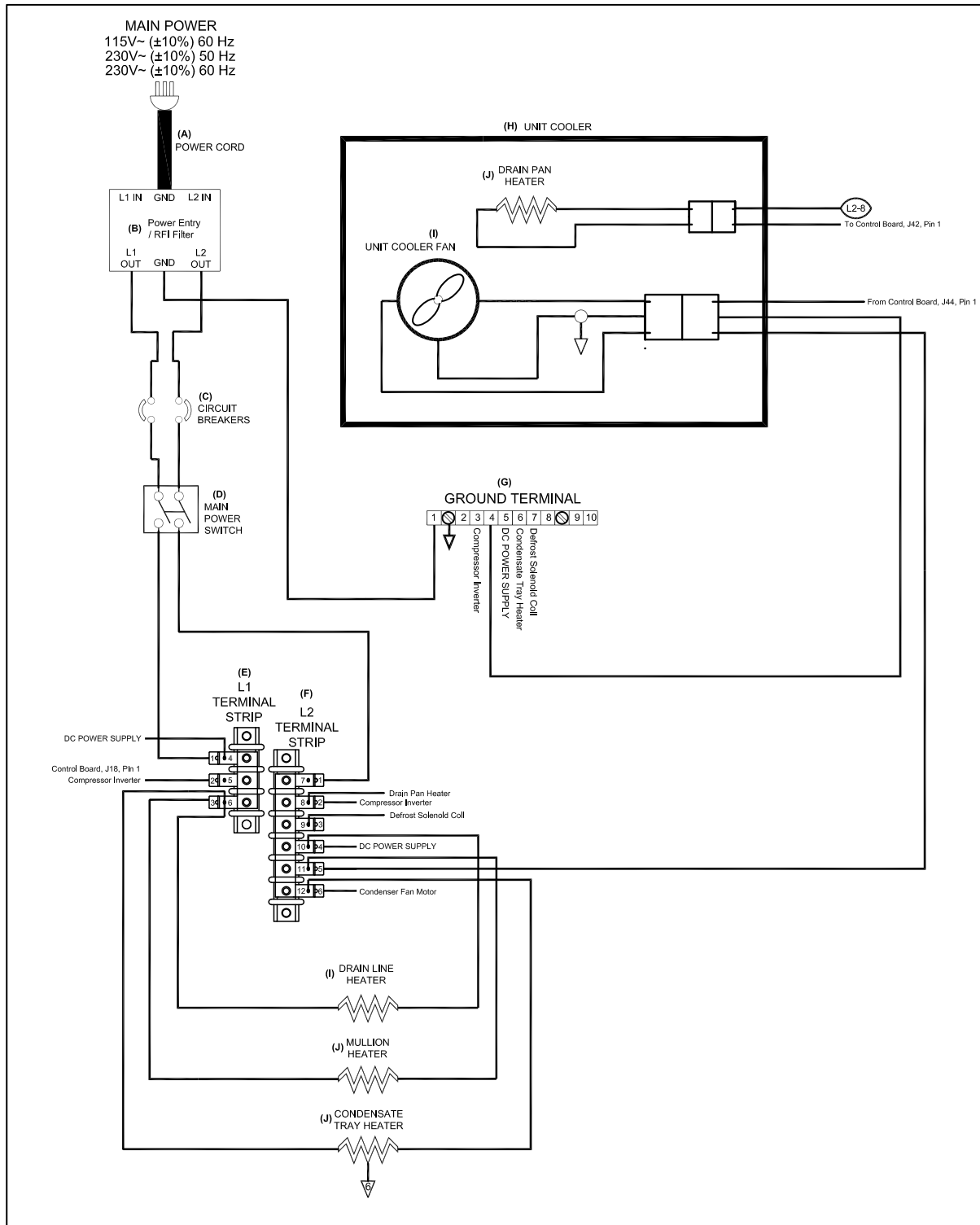

Horizon Series

15.2 HBF and HLF Models (without Access Control)

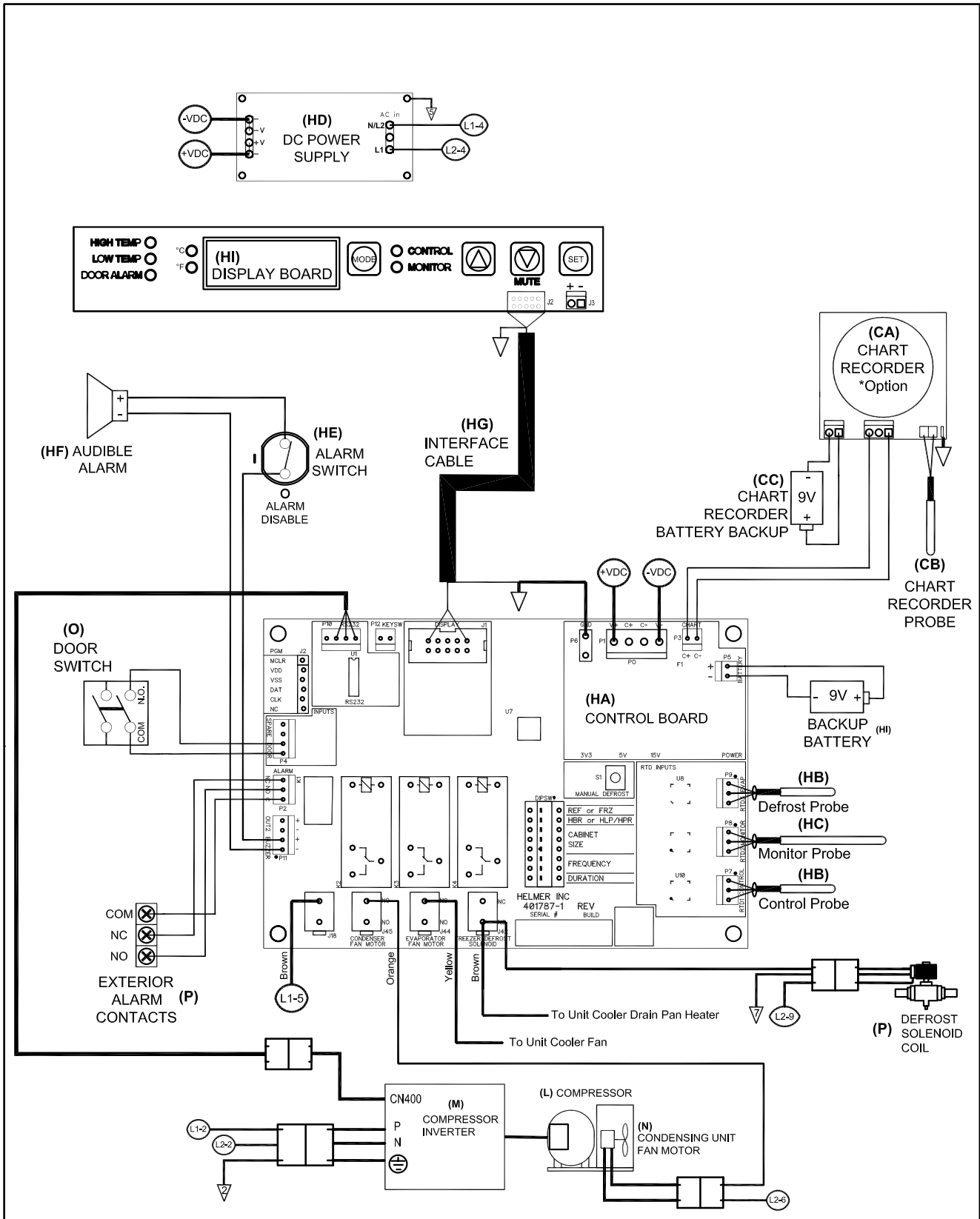

Horizon Series

15.3 HBF and HLF Models (with Access Control)

Horizon Series

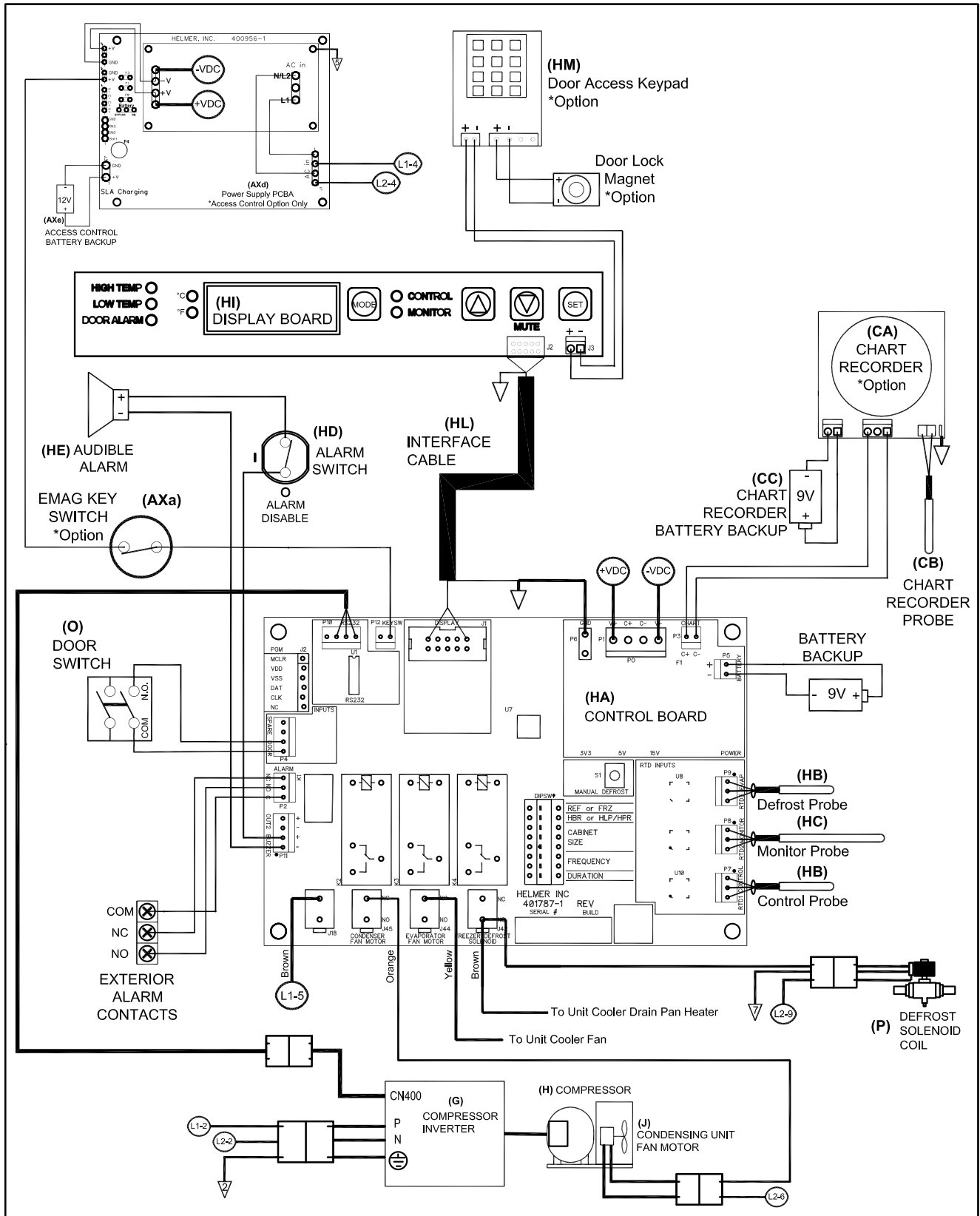

Appendix A: Warranty

Rel.i™ Product Warranty USA and Canada

For technical service needs, please contact Helmer at 800-743-5637 or www.helmerinc.com. Have the model and serial number available when calling.

Rapid Resolution

When a warranty issue arises it is our desire to respond quickly and appropriately. The service department at Helmer is there for you. Helmer will oversee the handling of your warranty service from start to finish. Therefore, Helmer must give advance authorization for all service calls and/or parts needs relating to a warranty issue. Any repeat service calls must also be authorized as well. This allows for proper diagnosis and action. Helmer will not be responsible for charges incurred for service calls made by third parties prior to authorization from Helmer. Helmer retains the right to replace any product in lieu of servicing it in the field.

Compressor

For the warranty period listed below, Helmer will supply the refrigeration compressor, if it is determined to be defective, at no charge, including freight. Helmer will not be liable for installation, refrigerant, or miscellaneous charges required to install the compressor beyond the first year of the warranty period.

- ◆ i.Series model compressor warranty period is five (5) years.
- ◆ Horizon Series model compressor warranty period is three (3) years.

Parts

For a period of two (2) years, Helmer will supply at no charge, including freight, any part that fails due to defects in material or workmanship under normal use, with the exception of expendable items. Expendable items such as glass, filters, light bulbs, and door gaskets are excluded from this warranty coverage. Inspection of defective parts by Helmer will be final in determining warranty status. Warranty procedures must be followed in all events.

Labor

For a period of one (1) year, Helmer will cover repair labor costs (including travel) and the cost of refrigerant and supplies necessary to perform authorized repairs. Repair service must be performed by an authorized Helmer service agency following the authorization process detailed above. Alternatively, your facility's staff may work with a Helmer technician to make repairs. Labor costs for repairs made by unauthorized service personnel, or without the assistance of a Helmer technician, will be the responsibility of the end user.

Additional Warranty Information

The time periods set forth above begin two (2) weeks after the original date of shipment from Helmer. Warranty procedures set forth above must be followed in all events.

THERE ARE NO WARRANTIES WHICH EXTEND BEYOND THE DESCRIPTION ON THE FACE HEREOF. THIS WARRANTY IS EXCLUSIVE AND IN LIEU OF ALL OTHER WARRANTIES, EXPRESS OR IMPLIED, INCLUDING WITHOUT LIMITATION ANY WARRANTY OF MERCHANTABILITY OR FITNESS FOR A PARTICULAR PURPOSE. NO WARRANTIES OF MERCHANTABILITY OR FITNESS FOR PARTICULAR PURPOSE SHALL APPLY.

THE LIABILITY, IF ANY, OF HELMER FOR DIRECT DAMAGES WHETHER ARISING FROM A BREACH OF ANY SALES AGREEMENT, BREACH OF WARRANTY, NEGLIGENCE, OR INDEMNITY, STRICT LIABILITY OR OTHER TORT, OR OTHERWISE WITH RESPECT TO THE GOODS OR ANY SERVICES IS LIMITED TO AN AMOUNT NOT TO EXCEED THE PRICE OF THE PARTICULAR GOODS OR SERVICES GIVING RISE TO THE LIABILITY. IN NO EVENT SHALL HELMER BE LIABLE FOR ANY INDIRECT, INCIDENTAL, CONSEQUENTIAL, OR SPECIAL DAMAGES, INCLUDING WITHOUT LIMITATION DAMAGES RELATED TO LOST REVENUES OR PROFITS, OR LOSS OF PRODUCTS.

This warranty does not cover damages caused in transit, during installation by accident, misuse, fire, flood, or acts of God. Further, this warranty will not be valid if Helmer determines that the failure was caused by a lack of performing recommended equipment maintenance (per Helmer manual) or by using the product in a manner other than for its intended use. Installation and calibration are not covered under this warranty agreement.

Outside of USA and Canada

Consult your local distributor for warranty information.

END OF MANUAL

Helmer Scientific

14400 Bergen Boulevard, Noblesville, IN 46060 USA
