

## Refrigerator Service and Maintenance Manual

i.Series® and Horizon Series™ - Undercounter

### Laboratory / Pharmacy

#### i.Series

iLR104-ADA, iLR105

#### Horizon Series

HLR104-ADA, HLR105

### Blood Bank

#### i.Series

iB104-ADA, iB105

#### Horizon Series

HB104-ADA, HB105



## Document History

Revision	Date	CO	Supersession	Revision Description
A	09 DEC 2016	12368	n/a	Initial release (all units with serial numbers 2036500 and greater) .
B	08 AUG 2017	12953	B supersedes A	<ul style="list-style-type: none"><li>• Updated pictures and part numbers for new handle and shelf.</li><li>• Updated Reverse Door Hinges and Handle instruction to include new handle.</li><li>• Updated Emergo Address.</li><li>• Updated WEEE directive text.</li></ul>
C	20 FEB 2018	13333	C supersedes B	<ul style="list-style-type: none"><li>• Updated hysteresis data.</li><li>• Clarified defrost event default settings in Table 7.</li><li>• Updated schematics to include changes in Horizon Access Control keypad and Defrost Timer.</li></ul>

\* Date submitted for Change Order review. Actual release date may vary.

## Document Updates

The document is furnished for information use only, is subject to change without notice and should not be construed as a commitment by Helmer Scientific. Helmer Scientific assumes no responsibility or liability for any errors or inaccuracies that may appear in the informational content contained in this material. For the purpose of clarity, Helmer Scientific considers only the most recent revision of this document to be valid.

## Notices and Disclaimers

### Confidential / Proprietary Notices

Use of any portion(s) of this document to copy, translate, disassemble or decompile, or create or attempt to create by reverse engineering or otherwise replicate the information from Helmer Scientific products is expressly prohibited.

### Copyright and Trademark

Copyright © 2018 Helmer, Inc. Helmer®, i.Series®, i.C<sup>3</sup>®, Horizon Series™, and Rel.i™ are registered trademarks or trademarks of Helmer, Inc. in the United States of America. All other trademarks and registered trademarks are the property of their respective owners. Helmer, Inc., doing business as (DBA) Helmer Scientific and Helmer.

### Disclaimer

This manual is intended as a guide to provide the operator with necessary instructions on the proper use and maintenance of certain Helmer Scientific products.

Any failure to follow the instructions as described could result in impaired product function, injury to the operator or others, or void applicable product warranties. Helmer Scientific accepts no responsibility for liability resulting from improper use or maintenance of its products.

The screenshots and component images appearing in this guide are provided for illustrative purposes only, and may vary slightly from the actual software screens and/or product components.

Helmer Scientific  
14400 Bergen Boulevard  
Noblesville, IN 46060 USA  
www.helmerinc.com  
ISO 13485 CERTIFIED

Part No. 360375/C

# Contents

- 1 About This Manual . . . . . 4**
  - 1.1 Intended Use . . . . . 4
  - 1.2 Safety Symbols and Precautions. . . . . 4
  - 1.3 Model and Input Power . . . . . 5
  - 1.4 Product Labels. . . . . 6
- i.Series Information . . . . . 7**
- 2 Installation and Configuration . . . . . 7**
  - 2.1 Location Requirements . . . . . 7
  - 2.2 Placement and Leveling . . . . . 7
  - 2.3 Stacked Undercounter Units . . . . . 7
  - 2.4 Connect Back-Up Power. . . . . 7
  - 2.5 Prepare for Monitoring. . . . . 8
  - 2.6 Configure Storage . . . . . 10
  - 2.7 Optional Adapter Kits for Medication Dispensing Locks . . . . . 11
  - 2.8 Reverse Door Hinges and Handle. . . . . 12
- 3 Controls. . . . . 15**
  - 3.1 Home Screen and Screensaver . . . . . 15
  - 3.2 Home Screen Functions . . . . . 15
  - 3.3 Alarm Reference . . . . . 15
  - 3.4 Settings . . . . . 16
  - 3.5 Sensor Calibration. . . . . 19
- 4 Maintenance . . . . . 23**
  - 4.1 Alarm Tests . . . . . 24
  - 4.2 Upgrade System Firmware . . . . . 25
  - 4.3 Test and Replace Back-up Batteries . . . . . 26
  - 4.4 Check Probe Bottle . . . . . 26
  - 4.5 Clean Refrigerator. . . . . 26
- 5 Service. . . . . 28**
  - 5.1 Refrigerant. . . . . 28
  - 5.2 Replace LED Lamp Strip. . . . . 28
  - 5.3 Remove / Replace Unit Cooler Cover . . . . . 29
- 6 Troubleshooting . . . . . 30**
  - 6.1 General Operation Problems. . . . . 30
  - 6.2 Chamber Temperature Problems . . . . . 30
  - 6.3 Alarm Activation Problems. . . . . 31
  - 6.4 Testing Problems. . . . . 32
  - 6.5 Condensation Problems . . . . . 33
- 7 i.Series Parts. . . . . 34**
- 8 Schematics . . . . . 37**
  - 8.1 iB and iLR Models; 104 and 105 Configuration. . . . . 37

**Horizon Series Information. . . . . 39**

**9 Installation and Configuration . . . . . 39**

9.1 Location Requirements . . . . . 39

9.2 Placement and Leveling . . . . . 39

9.3 Stacked Undercounter Units . . . . . 39

9.4 Connect Back-Up Power. . . . . 39

9.5 Prepare for Monitoring. . . . . 40

9.6 Configure Storage . . . . . 42

9.7 Optional Adapter Kits for Medication Dispensing Locks . . . . . 43

9.8 Reverse Door Hinges and Handle. . . . . 43

**10 Controls. . . . . 47**

10.1 Monitor and Control Interface . . . . . 47

10.2 Alarm Reference . . . . . 48

10.3 Settings . . . . . 49

**11 Maintenance . . . . . 52**

11.1 Alarm Tests . . . . . 53

11.2 Test and Replace Back-up Batteries . . . . . 54

11.3 Check Probe Bottle . . . . . 54

11.4 Clean the Refrigerator . . . . . 54

**12 Service. . . . . 56**

12.1 Refrigerant. . . . . 56

12.2 Replace LED Lamps . . . . . 56

12.3 Remove / Replace Unit Cooler Cover . . . . . 57

**13 Troubleshooting . . . . . 58**

13.1 General Operation Problems. . . . . 58

13.2 Chamber Temperature Problems . . . . . 58

13.3 Alarm Activation Problems. . . . . 59

13.4 Condensation Problems . . . . . 60

**14 Horizon Series Parts . . . . . 61**

**15 Schematics . . . . . 64**

15.1 HB and HLR Models; 104 and 105 Configuration (without Access Control) . . . . . 64

15.2 HB and HLR Models; 104 and 105 Configuration (with Access Control). . . . . 65

15.3 Defrost Timer for HB and HLR, Models; 104 and 105 Configuration. . . . . 66

**Appendix A: Compliance . . . . . 67**

**Appendix B: Warranty . . . . . 68**

## 1 About This Manual

This manual provides information on how to use i.Series® and Horizon Series™ undercounter laboratory, blood bank, and pharmacy refrigerators. It is intended for use by end users of the refrigerator and authorized service technicians.

Models are indicated by a distinguishing model number that corresponds to the series, type, number of doors, and capacity of the refrigerator. For example, “iLR105” refers to an i.Series Laboratory Refrigerator with 1 door and a capacity of 5 cu ft.

Generic references are used throughout this manual to group models that contain similar features. For example, “105 models” refers to all models of that size (iB105, HB105, iLR105, HLR105). This manual covers all undercounter refrigerators, which may be identified singly, by their size, or by their respective “Series.”

### 1.1 Intended Use

#### Note

This equipment has been tested and found to comply with the limits for a Class A digital device, pursuant to part 15 of the FCC Rules. These limits are designed to provide reasonable protection against harmful interference when the equipment is operated in a commercial environment. This equipment generates, uses and can radiate radio frequency energy and, if not installed and used in accordance with the instruction manual, may cause harmful interference to radio communications. Operation of this equipment in a residential area is likely to cause harmful interference in which case the user will be required to correct the interference at his own expense.

Helmer refrigerators are intended for the storage of blood products and other medical and scientific products.

### 1.2 Safety Symbols and Precautions

#### *Symbols found in this document*

The following symbols are used in this manual to emphasize certain details for the user:



**Task** Indicates procedures which need to be followed.



**Note** Provides useful information regarding a procedure or operating technique when using Helmer Scientific products.



**NOTICE** Advises the user against initiating an action or creating a situation which could result in damage to equipment; person injury is unlikely.



**CAUTION** Advises the user against initiating an action or creating a situation which could result in damage to equipment or impair the quality of the products or cause minor injury.



**WARNING** Advises the user against initiating an action or creating a situation which could result in damage to equipment and serious personal injury to a patient or the user.











Manufacturer



Authorized representative in the European Community

*Symbols found on the unit*

The following symbols may be found on the refrigerator or refrigerator packaging:

	CE Mark (European units only)		Earth / ground terminal
	Caution: Risk of damage to equipment or danger to operator		Protective earth / ground terminal
	Caution: Hot surface		Compliance with Restriction of Hazardous Substances Directive
	Caution: Shock / electrical hazard		Product falls under the scope of the WEEE (Waste Electrical and Electronic Equipment) directive.
	Caution: Unlock all casters		

**Safety Precautions**

**Avoiding Injury**

Review safety instructions before installing, using or maintaining the equipment.

- ◆ Before moving unit, ensure door is closed and casters (if installed) are unlocked and free of debris.
- ◆ Before moving unit, disconnect the AC power cord and secure the cord.
- ◆ Never physically restrict any moving component.
- ◆ Avoid removing electrical service panels and access panels unless so instructed.
- ◆ Keep hands away from pinch points when closing the door.
- ◆ Avoid sharp edges when working inside the electrical compartment and refrigeration compartment.
- ◆ Ensure biological materials are stored at recommended temperatures determined by standards, literature, or good laboratory practices.
- ◆ Proceed with caution when adding and removing samples from the refrigerator.
- ◆ Use manufacturer supplied power cord only.
- ◆ Using the equipment in a manner not specified by Helmer Scientific may impair the protection provided by the equipment.
- ◆ Ensure biological materials are stored safely, in accordance with all applicable organizational, regulatory, and legal requirements.
- ◆ The refrigerator is not considered to be a storage cabinet for flammable or hazardous materials.

 **CAUTION**

Decontaminate parts prior to sending for service or repair. Contact Helmer Scientific or your distributor for decontamination instructions and a Return Authorization Number.

**1.3 Model and Input Power**

 **Note**

Service information varies depending on the model and power requirements.

**Table 1. Model and Input Power**

Model	Voltage	Frequency	Current Draw
104	115V	60 Hz	5.0 A
105	115V	60 Hz	5.0 A
	230V	50 Hz	4.0 A
	230V	60 Hz	3.25 A

\* Amperage values are subject to change. Refer to the product specification label on your unit for current values.

### 1.4 Product Labels

This information appears on the product specification label, located on the rear of the refrigerator below the electrical box. The model also appears on a label located in the chamber on the upper side of the right wall.

**Note**

Information contained in this specification label varies depending on the model and power requirements.

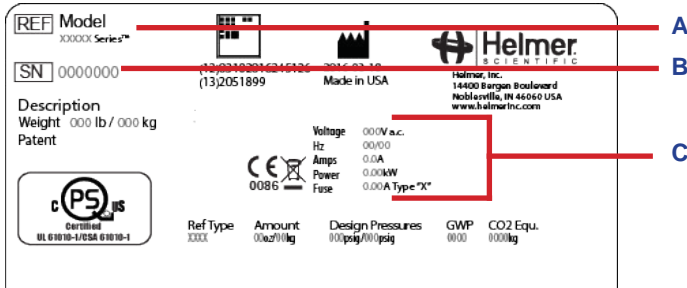

Label	Description
A	Model (REF)
B	Serial number
C	Power requirements

Sample Product Specification label.

# i.Series Information

## 2 Installation and Configuration

### 2.1 Location Requirements

- ◆ Grounded outlet meeting the electrical requirements listed on the product specification label.
- ◆ Clear of direct sunlight, high temperature sources, and heating and air conditioning vents.
- ◆ Minimum 3" (76 mm) of space behind unit.
- ◆ Meets limits specified for ambient temperature (15°C to 32°C) and relative humidity.

### 2.2 Placement and Leveling

#### CAUTION

- To prevent tipping, ensure the casters (if installed) are unlocked and the door is closed before moving the refrigerator.
- Do not sit, lean, push or place heavy objects on top surface.

1. Move refrigerator into place. Lock casters if installed.
2. Ensure refrigerator is level.

#### Note

Helmer recommends the use of leveling feet (unless casters are installed) and wall and floor brackets (PN 400472-2) for stabilization. Contact Helmer Technical Service for parts and instruction.

### 2.3 Stacked Undercounter Units

#### CAUTION

- For stacked configuration, both units must have leveling feet installed.
- Back brace bars and front stabilizing brackets must be installed (Blue - PN 400821-1; Stainless Steel - PN 400821-2).
- When stacking units, place the heavier unit on the bottom.
- Do not open multiple loaded drawers or baskets at the same time.

Contact Helmer or your distributor for more information regarding the stacking kit and methods to secure both units to the wall and / or floor.

### 2.4 Connect Back-Up Power

The monitoring system and chart recorder each have a back-up battery system, enabling a period of continuous operation if power is lost.

Battery life varies by manufacturer as well as voltage level remaining. Providing full power is available and no battery-related alarms are active, back-up power for the monitoring system is available for up to 20 hours (the Low Battery alarm will activate after approximately 18 hours of battery use). Providing full power is available, back-up power for the optional Access Control system is available for up to 2.5 hours.

#### CAUTION

Before installing or replacing batteries, switch AC power and back-up battery switch OFF. Disconnect refrigerator from AC power.

#### Notes

- The optional Access Control system uses the monitoring system back-up battery for back-up power in the event of power failure.
- The monitoring system will start on back-up battery power alone. If the refrigerator was not previously connected to AC power and the back-up battery is switched on, the monitoring system will begin running on back-up battery power.
- If AC power is lost, the monitoring system will automatically disable some features to prolong back-up battery power. Data collection will continue until back-up battery power is depleted.



The back-up battery is located below the chamber, behind the front panel. A panel cover must be removed to access the battery.



*Monitoring system back-up battery.*

## 2.5 Prepare for Monitoring

The back-up battery switch is switched off for shipping. Switch the back-up battery switch ON to provide the monitoring system and optional Access Control system with back-up power in the event of AC power failure.

### Temperature Probes

#### Notes

- Temperature probes are fragile; handle with care.
- Remote probes may also be introduced through the existing port and immersed in existing probe bottles.

The probe bottle along with a container of glycerin have been provided with this unit. The glycerin is mixed with water to create a solution which simulates the product stored in the refrigerator. The product simulation solution temperature reflects the product's temperature during normal operation.

The probe bottle should contain 4 oz. (120 mL) of product simulation solution at a 10:1 ratio of water to glycerin.

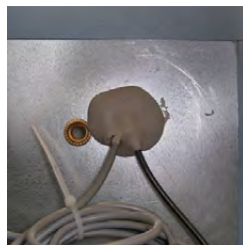
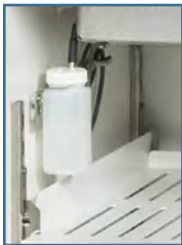

*Probe bottle with probe. Rear access port.*

#### Fill Probe Bottle

1. Remove all probes from bottle and remove bottle from bracket.
2. Remove cap and fill with 4 oz. (120 mL) of product simulation solution.
3. Install cap and place bottle in bracket.
4. Replace probes, immersing at least 2" (50 mm) in solution.

#### Install Additional Probe Through Rear Port

1. Peel back putty to expose port.
2. Insert probe through port into chamber.
3. Insert probe into bottle.
4. Replace putty, ensuring a tight seal.

**Chart Recorder (if included)****Note**

- If chart recorder has been operating on battery power, the battery should be replaced to ensure the back-up source has proper charge.
- For complete information, refer to the Temperature Chart Recorder Operation and Service Manual included with the unit.

The chart recorder has a back-up battery system, enabling a period of continuous operation if power is lost. Battery life varies by manufacturer as well as voltage level remaining. Providing full power is available, back-up power for the temperature chart recorder is available for up to 14 hours.

**Prior to use:**

Route the chart recorder probe through the rear access port and place in bottle with primary monitor probe.

**Set up and Operation**

Access chart recorder by pulling the door to open.

**Install Battery**

Connect the leads to the battery to provide back-up power to the chart recorder.

**Install / Replace Chart Paper****Notes**

- For accurate temperature reading, ensure the current time is aligned with the time line groove when chart knob is tightened.
- Contact Helmer Customer Service to reorder chart paper; part number 220366 (52 sheets).



*Chart recorder stylus and time line groove*

1. Press and hold **C** button. When stylus begins to move left, release button. The LED flashes.
2. When stylus stops moving, remove chart knob then move knob up and away.
3. Place chart paper on chart recorder.
4. Gently lift stylus and rotate paper so current time line corresponds to time line groove.
5. Hold chart paper in place while making sure the chart knob is fully tightened. *(Failure to fully tighten the knob can result in paper slipping and losing time.)*
6. Press and hold **C** button. When stylus begins to move right, release button.
7. Confirm stylus is marking on paper and stops at the correct temperature.
8. Calibrate chart recorder to match primary temperature if needed and close recorder door.

## External Monitoring Devices

The remote alarm interface is a relay switch with three terminals:

- ◆ Common (COM)
- ◆ Normally Open (NO)
- ◆ Normally Closed (NC)

Terminals are dry contacts and do not supply voltage. Interface circuit is either normally open or normally closed, depending on terminals used.

Requirements for your alarm system determine which alarm wires must connect to terminals.

### CAUTION

- The interface on the remote alarm monitoring system is intended for connection to the end user's central alarm system(s) that uses normally-open or normally-closed dry contacts.
- If an external power supply exceeding 33 V (RMS) or 70 V (DC) is connected to the remote alarm monitoring system's circuit, the remote alarm will not function properly and may cause damage to the control board or result in injury to the user.

The terminals on the remote alarm interface have the following maximum load capacity:

- ◆ 0.5 A at 125 V (AC)
- ◆ 1.0 A at 250 V (DC)

### Connect to Remote Alarm Interface

1. On the electrical box, locate the remote alarm terminals.
2. Connect remote alarm wires to appropriate terminals, according to requirements for your alarm system.
3. Use a cable tie to relieve strain on alarm wires (as necessary).

## 2.6 Configure Storage

### CAUTION

- Before moving drawers, ensure they are completely empty for safe lifting.
- Maximum basket, drawer, or shelf load is 100 lbs (46 kg).

### Note

Before moving storage components, protect stored items in refrigerator from extended exposure to adverse temperature.

## Product Loading Guidelines

When loading your refrigerator, take care to observe the following guidelines:

- ◆ Never load refrigerator beyond capacity.
- ◆ Always store items within shelves, drawers or baskets.
- ◆ Temperature uniformity is maintained by air circulation, which could be impeded if unit is overfilled, particularly at the top or back. Ensure proper clearance is provided below the fan.

### Note

Products stacked against back wall may obstruct air flow and affect performance of unit.

## Drawers and Baskets

### Remove Drawer or Basket

1. Pull drawer or basket out until it stops.
2. On the right rail, locate the release tab and press downward.
3. While holding the right release tab downward, locate the release tab on the left rail and press upward.
4. Pull drawer or basket free of slides.

### Install Drawer or Basket

1. Align end guides on drawer or basket with slides.
2. Gently push drawer or basket into chamber until it stops.
3. Pull drawer or basket out until it stops; check for smooth operation.

### Move Drawer Slides

1. Using a screwdriver, remove bracket retainers.
2. Tap brackets upward to disengage standards.
3. Remove slides from standards.
4. Insert slides into standard at appropriate height.
5. Tap brackets downward to engage standards.
6. Using a screwdriver, install bracket retainers.

## Shelves

### Remove Shelf

1. With one hand, lift front edge of the shelf from the front brackets.
2. With the other hand, reach under the shelf and bump rear edge of the shelf upward to disengage rear brackets.

### Install Shelf

1. Insert shelf into chamber, placing it on brackets.
2. Gently bump rear edge of the shelf downward to engage brackets.
3. Pulling shelf forward gently; shelf should not disengage from rear brackets

### Move Shelf Brackets

1. Using a screwdriver, remove bracket retainers.
2. Tap brackets upward to disengage standards.
3. Remove brackets from standards.
4. Insert brackets into standard at appropriate height.
5. Tap brackets downward to engage standards.
6. Using a screwdriver, install bracket retainers.

## 2.7 Optional Adapter Kits for Medication Dispensing Locks

Contact Helmer Technical Service or your distributor for service documentation pertaining to medication dispensing locks.

## 2.8 Reverse Door Hinges and Handle

### Notes

- The following instructions apply to reversing a right-hinged door to a left-hinged door. Some steps will need to be reversed if changing from left-hinged to right-hinged.
- Door hinge and handle cannot be reversed on units equipped with Access Control.
- Unit must be on floor or an elevated work surface with adequate space to place door face-down in front of unit.
- To prevent personal injury and/or damage to the door, Helmer recommends two people for this procedure.



### Remove Door and Hinges

1. With access panel cover closed, remove four screws securing the kick plate to the unit. Set kick plate and screws aside.
2. Open the front access panel and switch main power switch to OFF; switch back-up battery switch to OFF; disconnect AC power cord from power receptacle.
3. Remove six screws securing the access panel and cover to the unit and carefully place them in front of the unit ensuring there is no strain on the wiring.
4. Remove plug from access panel on handle-side of unit. Remove grommet from hole on hinged-side of unit and slide braided sleeve out of the slot.
5. Cut zip tie holding power cable inside the unit.



Units with serial 2041434 and prior



or

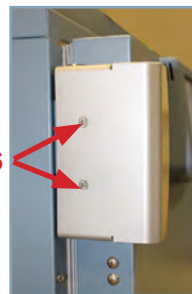

Units with serial number 2041435 and greater

6. Remove screws securing door handle assembly to the door and set assembly aside.
7. Remove screws attaching the latch plate to the unit and set aside.

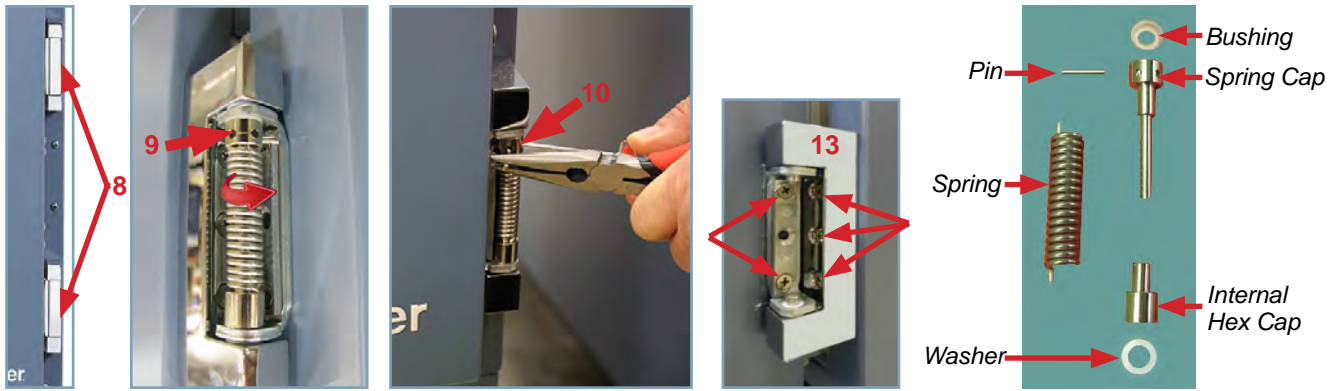

8. With door shut, remove cover plate from both hinges.
9. Remove the lower hinge spring assembly using a punch or J-hook tool to engage the left-most hole in the spring cap and rotate the spring cap from left to right and hold.
10. Using needle-nose pliers, remove the pin from the spring cap and slowly release spring back to the left.
11. Using a punch or J-hook tool to engage any hole in the spring cap, compress spring downward.
12. Remove spring assembly from lower hinge and set aside.
13. Supporting the door, remove five screws attaching lower hinge to door and unit, and noting the size and location of each screw. Set the hinge aside.
14. Remove the five screws attaching the upper hinge to the door and unit, and noting the size and location of each screw. Set the hinge aside.

**Reroute Communication Cables**

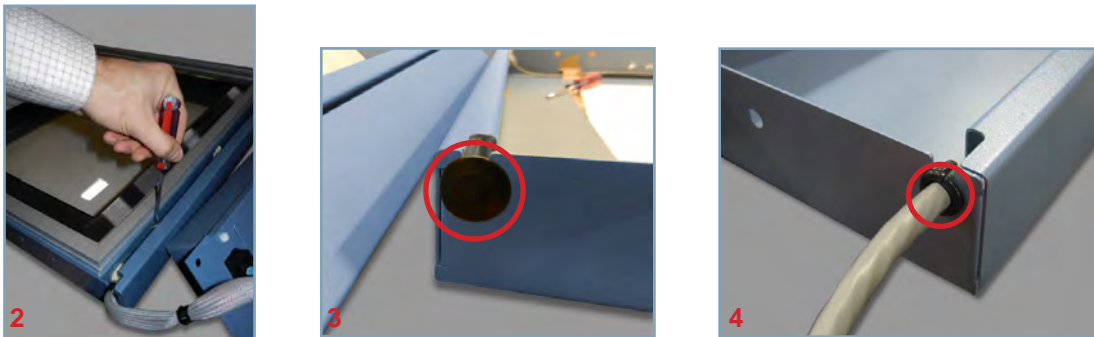

1. Carefully place door face-down in front of the unit taking care not to damage the display assembly and ensuring there is no strain on cables running from the cabinet to the door.
2. Remove the remaining screws from the door assembly. Using a punch or J-hook tool along the bottom edge, lift the inner door frame out of the outer door frame.
3. Remove the plug from the door on the handle-side and set aside.
4. Pull grommet out of hole in door on hinged-side and slide the braided sleeve out of the slot.

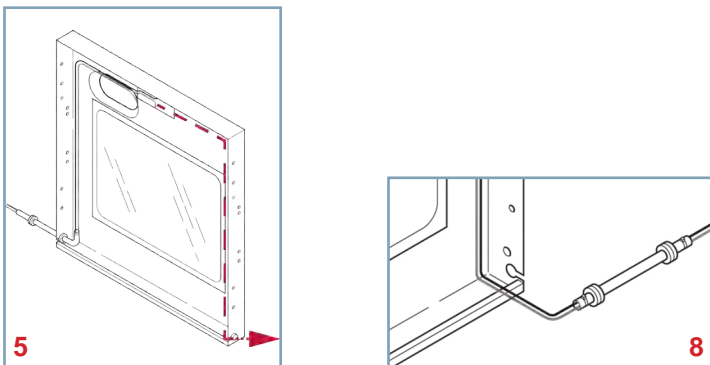

5. Reroute the power and communication cables along the inside edge of the door and through the slot in the corner opposite their initial location.
6. Tape cables to inside of door ensuring any excess cable is on the outside of the door.

7. Cut zip ties that are securing the braided sleeve and slide the sleeve and grommets along the cables toward the door.
8. Slip braided sleeve through the slot in the door and insert the door-side grommet into the hole in the door.
9. Secure braided sleeve around cables using zip ties at each end to prevent sleeve from sliding.

#### Reassemble Door / Reverse Hinges

1. Reinstall inner door panel and secure with screws in holes opposite original configuration.
2. Reinstall hinges onto opposite side of door frame by aligning holes in hinge plates with holes in door frame and hand-threading the two long screws in each hinge (leave screws slightly loose).
3. Lift door to cabinet and align holes in the hinge plates with the corresponding holes in the cabinet.
4. Hand-thread three short screws through hinge and into cabinet ensuring the weight of the door does not rest on the hinges.
5. Level the door and tighten all screws securing hinges to the unit.
6. Reroute power and communication cables across the front of the unit behind the access panel and secure with zip tie.
7. Slide the braided sleeve through the slot in the access panel allowing approximately 3" (76 mm) of slack between the door and the cabinet so door can open and close without straining cables. Install grommet in access panel.
8. Attach door handle on opposite side of door with four screws.
9. Attach strike plate and spacer to opposite side of unit with two screws. Test locking mechanism to ensure proper functionality.
10. With door closed, configure the hinge spring assembly for the opposite side of door.

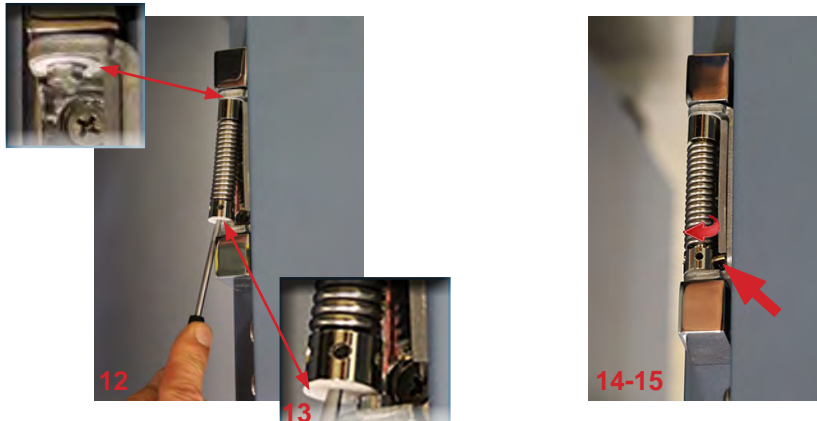

11. Orient the bend in the coil toward the front of the refrigerator and slide the internal hex cap with washer onto upper hex bolt in lower hinge plate.
12. Compress the spring upward using a punch or J-hook tool in the spring cap.
13. Slide the spring cap over the lower hex bolt in the lower hinge plate while compressing the spring.
14. Use a punch or J-hook tool to engage the right-most hole in the spring cap and rotate the spring cap from right to left, and hold.
15. Count four holes, beginning with and including the hole closest to the end of the coil, and insert the pin in the fourth hole.
16. Replace the hinge cover plates.
17. Reinstall access panel and cover securing with six screws.
18. Reinstall kick plate securing with four screws.
19. Plug power cord into power receptacle. Switch AC power switch ON. Switch back-up battery switch ON.
20. Verify door is level, hinges operate smoothly and door seals tightly.
21. Touch Mute to disable the high temperature alarm while refrigerator reaches operating temperature.

### 3 Controls

i.Series models are equipped with the i.C<sup>3</sup> monitoring and control system. The i.C<sup>3</sup> system combines temperature control and monitoring into a single user interface.

**Note**

Please refer to the i.C<sup>3</sup> User Guide for complete information regarding the i.C<sup>3</sup> User Interface.

#### 3.1 Home Screen and Screensaver

The Home Screen is the default screen and is displayed when:

- ◆ The Home icon is touched from any other screen.
- ◆ There is no interaction for two minutes on any screen other than those used to enter a password.



Home Screen

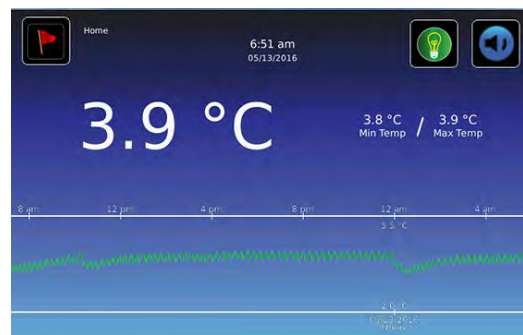

Screensaver

#### 3.2 Home Screen Functions

**Note**

Refer to the i.C<sup>3</sup> User Guide for options available on all i.C<sup>3</sup> screens.

- ◆ View current interior cabinet temperature readings
- ◆ View the current system time and date
- ◆ Access any of the five homescreen applications (touch **i.C<sup>3</sup> APPS** for additional applications)
- ◆ View information about current alarm events
- ◆ View whether the monitoring system is running on battery power
- ◆ Mute audible alarms
- ◆ Turn the chamber light on and off
- ◆ View a graph of the chamber temperature
- ◆ View unit ID
- ◆ Shortcut to Event Log

#### 3.3 Alarm Reference

If an alarm condition is met, an alarm activates. Some alarms are visual only; others are visual and audible. Some alarms are sent through the remote alarm interface. The table below indicates if an alarm is audible (A), visual (V), or sent through the remote alarm interface (R).

**Table 2. i.Series Alarm Reference**

Alarm	Alarm Type	Alarm	Alarm Type
High Temperature	A, V, R	Low Battery	V
Low Temperature	A, V, R	No Battery	A, V, R
Compressor Temperature	A, V, R	Probe Failure	A, V, R
Door Open (Time)	A, V, R	Communication Failure	A, V, R
Power Failure	A, V, R		

i.Series Information



### 3.4 Settings



Through the i.C³ monitoring and control system, current settings may be viewed and changed. To view settings, touch **i.C³ APPS, Settings**. Use a touch-drag motion to scroll up or down to select the desired setting.

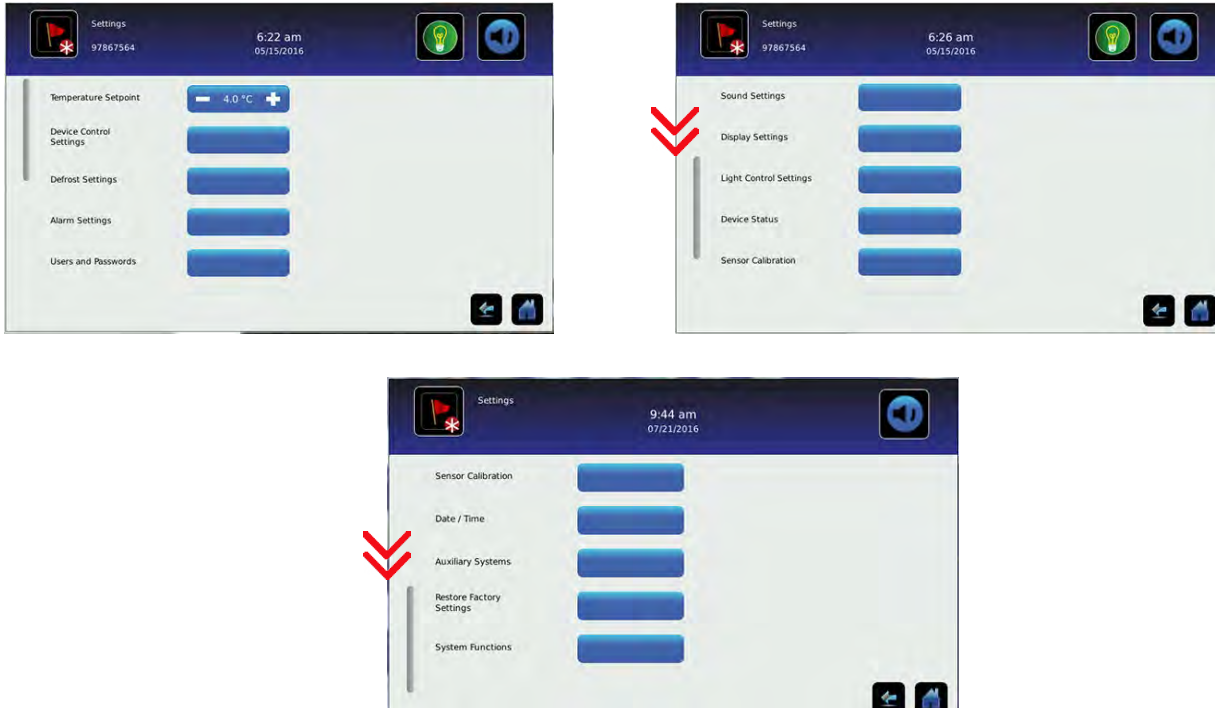

Settings screens

#### Notes

- If the Settings screen is password protected enter appropriate password. If viewing settings for the first time, enter factory default password of “1234”.
- Default values for general settings, alarm settings, and display settings are available in the i.C³ User Guide.
- Changing temperature settings affects operation of the refrigerator. Do not change settings unless instructed in product documentation or by Helmer Technical Service.

The i.C³ temperature monitor and controller is programmed at the factory. To change a setting, first enter the Settings screen, then select the setting. The method for accessing the Settings mode for each setting varies.

#### Device Control Settings

Device control settings are programmed at the factory. Setpoints can be viewed and changed through the i.C³ monitoring and control system. To view temperature setpoints, touch **i.C³ APPS, Settings, Device Control Settings**.



Device Control Settings screen.

**Table 3. Setpoints**

Setting	Initial Factory Value	
	105	104
Temperature Setpoint	4.0 °C	
Hysteresis Setpoint <small>* = low humidity models with serial numbers prior to 2047345</small>	2.0 °C	1.2 °C
	1.0 °C*	0.5 °C*
Delay on Start-Up	2 minutes	
Duty Cycle During Control Probe Error	50%	

**Temperature Setpoint**

The setpoint is the temperature at which the refrigerator operates.

**Notes**

- If the Settings screen is password protected enter appropriate password. If viewing settings for the first time, enter factory default password of “1234”.
- Temperature Setpoint can be adjusted through the main Settings screen and Device Control Settings.
- Change the setpoint if your organization requires a chamber temperature other than 4.0 °C.

**Change Temperature Setpoint**

1. Touch **i.C<sup>3</sup> APPS, i.C<sup>3</sup> Settings**.
2. Enter the Settings password.
3. Touch minus (-) or plus (+) on the **Temperature Setpoint** spin box.

**Hysteresis Setpoint**

Hysteresis is the allowable temperature variance on each side of the refrigerator setpoint.

**Delay on Start-Up**

Compressor startup is delayed to allow the i.C<sup>3</sup> monitoring and control system to start first.

**Duty Cycle During Control Probe Error**

The duty cycle is the percentage of time the compressor will run in the event of a temperature control failure.

**Note**

Hysteresis, Delay on Start-up and Duty Cycle During Control Probe Error are factory-preset and should not be changed unless directed by Helmer Technical Service.

The following alarm settings may be changed by the operator. The setpoint for temperature alarms may be changed (where applicable), as well as the time delay between when the alarm condition commences and when the visual and audible alarms are initiated.

**Table 4. User Configurable Alarms**

Alarm	Description	Default Value	Default Time Delay
Primary Monitor Probe High Temp	High temperature at which alarm condition occurs	5.5 °C	0 minutes
Primary Monitor Probe Low Temp	Low temperature at which alarm condition occurs	1.5 °C (blood bank refrigerators)	0 minutes
		2.0 °C (laboratory and pharmacy refrigerators)	
Compressor High Temp	High temperature at which alarm condition occurs	50 °C	0 minutes
Power Failure	Time after power failure occurs until alarm sounds	-	1 minute
Probe Failure	Time after probe failure occurs until alarm sounds	-	0 minutes
Door Open (Time)	Time door remains open until alarm sounds	-	3 minutes

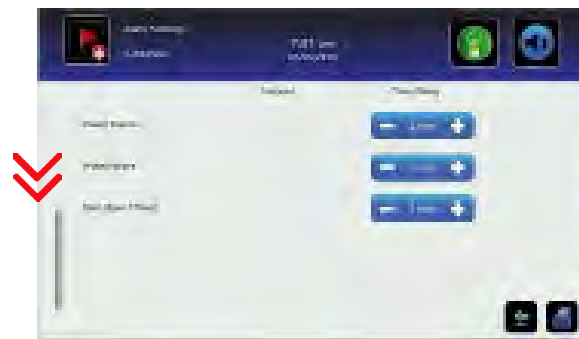
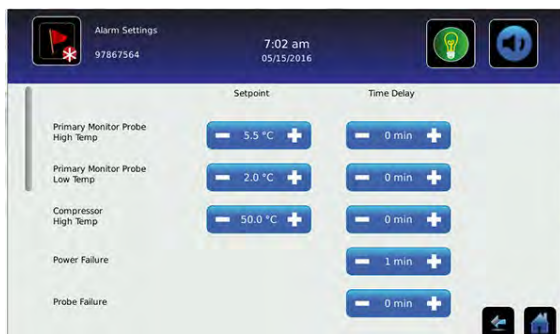

Alarm setting screens

**Change an Alarm Setting**

1. Touch **i.C³ APPS, Settings**.
2. Enter the Settings password (default password is "1234").
3. Scroll down and touch **Alarm Settings**.
4. Touch minus (-) or plus (+) on the spin box corresponding to the alarm setting to be changed.
5. Touch **Home** to exit the Alarm Settings screen.

**Non-Configurable Alarms**

The following alarms indicate operational conditions which require the attention of the operator or a qualified service technician.

**Table 5. Non-Configurable Alarm**

Alarm	Description
Low Battery	Rechargeable battery voltage is low
Communication Failure	<p><b>Communication Failure 1</b></p> <ul style="list-style-type: none"> <li>• Triggered if communication is lost between i.C³ display board and control board</li> <li>• Unit will continue to run with previously saved settings</li> <li>• Screen will not display temperature changes or alarm conditions</li> <li>• i.C³ system will continue to reset until connection is re-established</li> </ul> <p><b>Communication Failure 2</b></p> <ul style="list-style-type: none"> <li>• Triggered if communication is lost between i.C³ display board and internal system memory</li> <li>• Unit will continue to run with previously saved settings</li> </ul> <p><b>Communication Failure 3</b></p> <ul style="list-style-type: none"> <li>• Triggered if the database is corrupted</li> <li>• The database is archived and a new database is automatically created</li> <li>• Unit will continue to run with previously saved settings</li> </ul>

### 3.5 Sensor Calibration



Sensor calibration values are programmed at the factory. Calibration values can be viewed and changed through the i.C³ monitoring and control system. To view calibration settings, touch **i.C³ APPS**, **Settings**, and scroll down to **Sensor Calibration**.

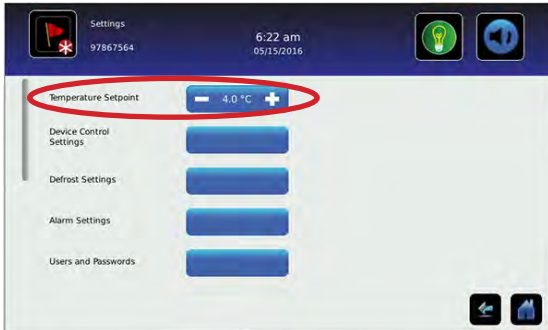

Settings Screen



Sensor Calibration screens

#### Notes

- If the Settings screen is password protected enter appropriate password. If viewing settings for the first time, enter factory default password of “1234”.
- After one hour of no interaction, the Home screen or Temperature Graph screensaver (if enabled) is displayed.
- The Compressor Probe offset is factory-preset and should not be changed unless directed by Helmer Technical Service.

#### Primary Monitor Probe

Verify primary monitor probe is reading chamber temperature correctly by comparing probe readings to the temperature measured by a calibrated reference thermometer. If the probe is not reading correctly, change the value displayed on the monitor.

The factory default setting for the primary monitor probe is 4.0°C.

#### Notes

- Ensure product simulation bottle is full of solution.
- The probe in the bottle is connected to the monitoring system and senses chamber temperature. This probe activates the temperature alarms but does not affect refrigerator setpoint.

i.Series Information

 **Calibrate Primary Monitor Probe**

1. Remove primary monitor probe from the probe bottle.
2. Unscrew the cap from the bottle.
3. Attach a calibrated independent reference thermometer traceable per national standards to the primary monitor probe, and place them in the bottle. The probe and thermometer should be immersed at least 2" (50 mm).
4. Close the door and allow the chamber temperature to stabilize.
5. Observe and note the thermometer temperature. If the independent thermometer corresponds to the displayed temperature, proceed to **Step 9**.
6. Subtract the displayed temperature reading from the independent probe reading to determine the offset value.
7. Touch, **i.C³ APPS, Settings, Sensor Calibration**.
8. Touch minus (-) or plus (+) on the corresponding spin box to increase or decrease the value by the value calculated in **Step 6**. The message "New Setting Saved" appears next to the spin box.
9. Remove thermometer from probe.
10. Replace bottle cap, ensuring a tight fit.
11. Place probe in bottle, immersing at least 2" (50 mm).

**Control Sensor**

The temperature controller senses unit cooler temperature through the control probe in the unit cooler. The unit cooler temperature typically varies from the chamber temperature, so an offset value is used by the control system to compensate for the difference.

The temperature controller adjusts chamber temperature around the refrigerator setpoint by activating the compressor when the control probe registers above the setpoint based on the hysteresis value.

 **Determine Control Sensor Offset:**

 **NOTICE**

- Control Sensor Offset is factory-preset and should not be changed. Contact Helmer Technical Service for instructions regarding changing the Control Sensor Offset.
- Monitor temperature must be verified and accurate prior to adjusting the Control Sensor Offset.

1. View and record the Refrigerator Setpoint.
2. Allow unit to run with calibrated monitor temperature for several compressor cycles, and record the average monitor temperature.
3. View and record the current Control Offset value.
4. Subtract the Refrigerator Setpoint from the average monitor temperature and record the difference.
5. Add the current Control Offset value to the recorded difference determined in the previous step to establish the new Control Offset value.

Example 1	Example 2
Refrigerator setpoint is 4.0	Refrigerator setpoint is 4.0
Average monitor temperature is 5.2	Average monitor temperature is 2.8
Current Control Offset is 0.3	Current Control Offset is 0.3
Subtract: $5.2 - 4.0 = 1.2$ (difference between average temperature and setpoint)	Subtract: $2.8 - 4.0 = -1.2$ (difference between average temperature and setpoint)
Add: $0.3 + 1.2 = 1.5$ (new control offset value)	Add: $0.3 + (-1.2) = -0.9$ (new control offset value)

 **Enter New Offset Value:**

1. Touch **i.C³ APPS, Settings**.
2. Enter the Settings password.
3. Touch **Sensor Calibration**.
4. Touch minus (-) or plus (+) on the **Control Probe Offset** spin box.
  - ◆ Raise the offset value to lower chamber temperature; lower the offset value to raise chamber temperature.
5. Touch **Home** to return to home screen.

**Compressor Probe**

The compressor temperature probe has been factory-calibrated. Changing the calibration setting is not typically necessary and should not be performed unless directed by Helmer Technical Service.

### Factory Default Settings

Settings listed below may be simultaneously returned to factory default values.

 **Note**

The factory default settings may not be the same as the settings that were factory-calibrated before the refrigerator was shipped.

**Table 6. Default Settings**

Setting	Restored Value	
Home Screen Application Icons	i.C <sup>3</sup> APPS, Settings, Temperature Graph, Temperature Alarm Test, Information Logs	
Display Brightness	High (3 symbols)	
Password (for Settings screen)	1234	
Sounds	On	
Alarm Volume	9	
Alarm Tone	3	
Temperature Calibration Values	Not affected (values previously entered during setup)	
Unit ID	Not affected (previously selected during setup)	
Date Format	MM/DD/YYYY	
Day	Not affected (maintained in real-time clock)	
Month		
Year		
Time Format	12-hour	
Minute	Not affected (maintained in real-time clock)	
Hour		
AM/PM		
Language	Not affected (Language previously selected during setup)	
Temperature Units	°C	
Password Protection (for Settings screen)	On	
Temperature Graph Screensaver	On	
Access Control (optional) as Home Page	On	
Light Off Delay (on/off)	On	
Light Off Delay	5 minutes	
High Temperature Alarm Setpoint	5.5 °C	
High Temperature Alarm Time Delay	0 minutes	
Low Temperature Alarm Setpoint (includes iLR and iPR models originally set at 2.0 °C)	1.5 °C (iB models) 2.0 °C (iLR and iPR models)	
Low Temperature Alarm Time Delay	0 minutes	
Power Failure Alarm Time Delay	1 minute	
Probe Failure Alarm Time Delay	0 minutes	
Door Open (Time) Alarm Time Delay	3 minutes	
Compressor Temperature Alarm Setpoint	50.0 °C	
Compressor Temperature Alarm Time Delay	0 minutes	
Chamber Setpoint	4.0 °C	
Chamber Hysteresis	105 models	104 models
* = low humidity models with serial numbers prior to 2047345	2.0 °C (120 V) 1.0 °C (120 V)* 1.0 °C (230 V)	1.2 °C 0.5 °C*
Delay on Start-Up	2 minutes	

**Additional Factory Default Settings for Models with Low Humidity Option****Table 7. Low Humidity Unit Default Settings**

Setting	Restored Value (105 models)	Restored Value (104 models)
Control Relay Probe Failure Duty Cycle	50%	50%
Defrost Event #1 On/Off	On	Off
Defrost Event #1 Start Time	12:15 AM	12:15 AM
Defrost Event #2 On/Off	On	On
Defrost Event #2 Start Time	8:00 AM	6:00 AM
Defrost Event #3 On/Off	On	Off
Defrost Event #3 Start Time	4:00 PM	4:00 PM
Defrost Event #4 On/Off	Off	On
Defrost Event #4 Start Time	6:00 PM	6:00 PM
Defrost Time/Defrost Safety Operation Time	15 minutes	15 minutes

**Note**

Defrost event settings are only applicable to models with the low humidity option.

**Restore Settings:**

1. Touch the **Settings** icon.
2. Scroll down and touch the **Restore Factory Settings** button. The Restore Factory Settings confirmation box appears.
3. Touch  to restore the factory settings or  to maintain the current settings and clear the message.

## 4 Maintenance

Maintenance tasks should be completed according to the schedule below. Refer to the service manual and the i.C³ User Guide for more detail on completing the various tasks.

 **CAUTION**

Maintenance should only be performed by trained refrigeration technicians.

 **Notes**

- The preventive maintenance schedule provides recommended minimum requirements. Regulations or physical conditions at your organization may require maintenance items be performed more frequently, or only by designated service personnel.
- Before performing maintenance, protect items in refrigerator from extended exposure to adverse temperature.
- Allow refrigerator temperature to stabilize at setpoint after performing service or after extended door opening.

**Table 9. i.Series Preventive Maintenance Schedule**

Task	Frequency			
	Quarterly	1 year	2 years	As Needed
Test the high and low temperature alarms.	✓			
Test the power failure alarm (as required by your organization's protocols).	✓			
Test the door alarm (as required by your organization's protocols).				✓
Check the temperature calibration on the monitor and change it if necessary.	✓			
Replace i.Series back-up battery			✓	
Check solution level in probe bottle. Refill or replace solution if necessary.				✓
Examine the probe bottles and clean or replace if necessary.		✓		
Check the chamber lights and replace them if necessary.				✓
Clean the condenser grill.	✓			
Clean the door gaskets, interior, and exterior of the refrigerator.				✓
<b>Electrical compartment:</b>	✓			
<ul style="list-style-type: none"> <li>• Inspect electrical components and wiring terminal strips for discoloration. If found, contact Helmer Technical Service.</li> <li>• Inspect wiring terminal strips for secure connections. Tighten connections as necessary.</li> </ul>				
<b>Models with chart recorders</b>				✓
Check the back-up battery for the chart recorder after an extended power failure and change it if necessary, or change the battery if it has been in service for one year. Refer to the Temperature Chart Recorder Operation and Service Manual.				

 **NOTICE**

Clean the condenser grill on a quarterly basis.

 **Notes**

- During a power failure the back-up battery provides power to the monitoring system, power failure alarm, and optional Access Control. If the back-up battery is not functioning, the power failure alarm will not be activated and the battery should be replaced.
- During a power failure, the back-up battery continues to provide power to the optional Access Control lock (if equipped). If the back-up battery is not functioning, the optional Access Control lock will not secure the door.



## 4.1 Alarm Tests



Test alarms to ensure they are working correctly. The refrigerator has alarms for chamber temperature, compressor temperature, door open (time), power failure, low battery, and power failure. To initiate alarm tests, touch **i.C³ APPS**, **Temperature Alarm Test**.

### Automatic Chamber Temperature Alarm Test



Temperature Alarm Test screen

#### Notes

- Test can be aborted by touching **Cancel Test**.
- Test is only applicable to the primary monitor probe.
- Test takes less than five minutes.
- If the temperature alarm test does not complete successfully, restart the i.C³ monitoring system.

When performing an automatic temperature alarm test, the Peltier device heats or cools the primary monitor probe until the high or low alarm setpoint is reached. An event is added to the Event Log to indicate a temperature alarm was activated. The Alarm Test icon is displayed on the Temperature Graph to indicate the temperature alarm was test-induced.

#### Test the Low Alarm:

1. Identify current setting for low alarm setpoint.
2. Touch **i.C³ APPS**, **Temperature Alarm Test**.
3. Touch **Low Alarm Test**.
4. "Peltier Test Probe Cooling" message appears.
5. When displayed temperature reaches the alarm setpoint, an alarm is activated.
6. When completed, "Test Complete" appears.
7. Touch **i.C³ APPS**, **Information Logs**, **Event Log**. Touch the event to view event details.
8. Observe the temperature at the time of the low temperature alarm event. Compare this to the alarm setpoint.



#### Test the High Alarm:

1. Identify current setting for high alarm setpoint.
2. Touch **i.C³ APPS**, **Temperature Alarm Test**.
3. Touch **High Alarm Test**.
4. "Peltier Test Probe Warming" message appears.
5. When displayed temperature reaches the alarm setpoint, the temperature reading turns red.
6. When completed, "Test Complete" appears.
7. Touch **i.C³ APPS**, **Information Logs**, **Event Log**. Touch the event to view event details.
8. Observe the temperature at the time of the high temperature alarm event. Compare this to the alarm setpoint.



 **Cancel the Test:**

1. Touch **Cancel Test** icon to end the alarm test. “*Test Stopped*” is displayed in the Test Status section of the display.

 **Note**

When cancelling an automatic test, the message indicating the test is in progress clears immediately. If a setpoint was reached before the test was cancelled, the alarm activates and clears as described earlier.

**Manual Chamber Alarm Test** **NOTICE**

- Perform the low alarm test before the high alarm test to control the temperature more closely and complete the testing more quickly.
- Before testing alarms, protect items in the unit from extended exposure to adverse temperature.
- Temperature probes are fragile; handle with care.

 **Test the Low Alarm:**

1. Identify setting for low alarm setpoint.
2. Remove primary monitor probe from bottle.
3. Immerse probe in glass filled with water that is approximately 4 °C. Slowly add crushed ice to lower temperature.
4. When low temperature alarm sounds, note the temperature on the i.C<sup>3</sup> display.
5. Compare the temperature at which the alarm sounds to the low alarm setpoint.

 **Test the High Alarm:**

1. Identify setting for high alarm setpoint.
2. Immerse probe in glass filled with water that is approximately 4 °C. Slowly add warm water to raise temperature.
3. When high temperature alarm sounds, note the temperature on the i.C<sup>3</sup> display.
4. Compare the temperature at which the alarm sounds to the high alarm setpoint.
5. Remove probe from warm water.
6. Place primary monitor probe in probe bottle, immersing it at least 2” (50 mm).

**Power Failure Alarm Test** **Note**

During a power failure, the power failure alarm sounds and the battery provides power to the monitoring system and optional Access Control lock.

1. Change Power Failure delay setting to 0 minutes by touching **Home, Settings, Alarm Settings**, then touching + or – on the Power Failure spin box to change the value to 0.
2. Switch AC ON/OFF switch OFF. Power failure alarm will activate immediately.
3. Switch AC ON/OFF switch ON. Power failure alarm will clear and audible alarm will cease.
4. Change Power Failure time delay to the original setting.

**Door Open Alarm Test**

1. Change Door Open (Time) delay setting to 0 minutes by touching **Home, Settings, Alarm Settings**, then touching + or – on the Door Open (Time) spin box to change the value to 0.
2. Open door. Alarm will activate immediately.
3. Close door. Alarm will clear, and audible alarm will cease.
4. Change the Door Open (Time) setting to the original setting.

**4.2 Upgrade System Firmware**

Helmer may occasionally issue updates for the i.C<sup>3</sup> firmware. Follow upgrade instructions included with the firmware update.

### 4.3 Test and Replace Back-up Batteries

#### i.C<sup>3</sup> Monitoring System Back-up Battery

On all i.C<sup>3</sup> screens, the Battery icon will appear in the header bar when the system is running on battery power and the screen brightness will automatically be reduced. The monitoring system will automatically disable some features to extend battery life.

##### Check the Battery.

- ◆ Switch AC ON/OFF switch OFF.
- ◆ The screen should continue to display information with reduced brightness and the battery icon will appear on the screen. If the display is blank, replace the battery.
- ◆ When completed, switch AC ON/OFF switch ON.

##### Note

Use a battery which meets manufacturer's specifications.

#### Access Control Back-up Battery (Optional)

During an AC power failure, the Access Control back-up battery provides back-up power to operate the magnetic Access Control lock.

##### Test Access Control Back-up Battery.

1. Ensure monitoring system / Access Control battery key switch is switched ON.
2. Switch AC ON/OFF switch OFF.
3. Attempt to open the cabinet door.
4. If the door remains locked, the battery is functional.
5. If the door does not remain locked, replace the battery.
6. Switch AC ON/OFF switch ON.

#### Chart Recorder Back-up Battery (if included)

Refer to 360076-1 Temperature Chart Recorder Operation and Service Manual.

### 4.4 Check Probe Bottle

Remove the probe bottle from the bracket and inspect for cracks. Replace the bottle if necessary.

Ensure the probe bottle has approximately 4 oz. (120 mL) of product simulation solution (10:1 ratio of water to glycerin). The glycerin is used to create a solution which simulates the product stored in the refrigerator. The product simulation solution temperature reflects the product's temperature during normal operation. Failure to fill the bottle may prevent the chamber temperature from stabilizing at the temperature setpoint. The probe should be immersed at least 2" (50 mm).

### 4.5 Clean Refrigerator

#### Cabinet Exterior

Clean glass surfaces with soft cotton cloth and glass cleaner. Clean exterior surfaces with soft cotton cloth and non-abrasive liquid cleaner.

##### CAUTION

The condensate evaporator and water evaporation tray are hot.

#### Cabinet Interior

Clean painted surfaces with mild detergent. Clean stainless steel surfaces with a general-purpose laboratory cleaner suitable for stainless steel.

## Condenser Grill

### CAUTION

Disconnect refrigerator from AC power when cleaning.

If the refrigerator is located in an environment where it is exposed to excessive lint or dust, the condenser grill may require cleaning more frequently than stated in preventive maintenance schedule.

Clean the condenser grill using a soft brush and a vacuum cleaner.

## Door Gasket

Clean with soft cloth and mild soap and water solution.

## Probe Bottles

### Clean and Refill Probe Bottles

1. Remove all probes from bottle.
2. Remove bottle from bracket and empty any remaining solution
3. Clean bottle with a 1:9 ratio of bleach to water solution or a company approved cleaner/disinfectant.
4. Refill bottle with 4 oz. (120 mL) of product simulation solution (10:1 ratio of water to glycerin).
5. Cap bottle tightly to minimize evaporation.
6. Place bottle in bracket.
7. Replace probes, immersing at least 2" (50 mm).

## i.C<sup>3</sup>® Touchscreen

Clean touchscreen with a soft, dry cotton cloth.

## 5 Service

### 5.1 Refrigerant

#### CAUTION

- Review all safety instructions prior to recharging refrigerant. Refer to **Section 1.1** (Safety).
- Maintenance should only be performed by trained refrigeration technicians.

#### Notes

- Use only non-CFC R134A refrigerant.
- Pressure readings may vary based on chamber temperature and ambient air temperature.
- Normal low side pressures are 16 psi to 18 psi when unit is functioning at standard operating temperatures and measured at the end of the compressor cycle.
- If a refrigerant leak is suspected, Helmer recommends finding and fixing the leak prior to recharging the unit.

Full initial refrigerant charge varies by size of compressor and date of manufacture. Applicable charge values are found in Table 8.

**Table 8. Refrigerant Charge**

Horsepower	Refrigerant	Initial Charge	Serial Number
1/4	R134A	9.5 oz. (269 g)	less than 2004753
1/6	R134A	4.5 oz. (128 g)	2004753 and greater

### 5.2 Replace LED Lamp Strip

1. Switch battery switch OFF. Switch AC ON/OFF switch OFF.
2. Using a screwdriver, remove lamp strip from chamber wall.
3. Unsnap the defective LED and disconnect wires.
4. Snap new LED onto the lamp strip.
5. Connect the wires.
6. Using a screwdriver, attach lamp strip to chamber wall.
7. Switch AC ON/OFF switch ON. Switch battery switch ON.
8. Touch **Light** button or open door to test lamp.
9. Touch **Mute** to disable the high temperature alarm while refrigerator reaches operating temperature.

### 5.3 Remove / Replace Unit Cooler Cover

The unit cooler cover must be removed when servicing the control probe, fan motor(s) or coil.

#### NOTICE

If unit cooler cover is not removed as detailed in this procedure the drain port may be damaged. Improper drainage may result in excessive icing and refrigerator's inability to maintain temperature.

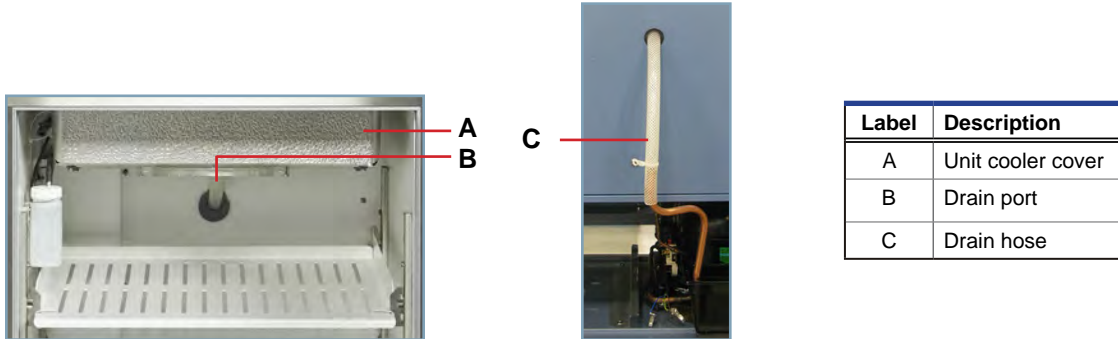

Drain line and hose.

#### Remove Unit Cooler Cover

#### CAUTION

The condensate evaporator and water evaporation tray are hot.

1. Switch AC ON/OFF switch OFF. Switch battery switch OFF.
2. Remove top drawer, basket, or shelf from the chamber.
3. On back of cabinet, peel putty back to expose drain hose.
4. Pull drain hose downward while gently twisting to remove from unit cooler drain port.
5. Push drain hose out through rear of chamber.
6. Hold unit cooler cover in place to prevent dropping. Using a 5/16" socket wrench, remove four screws securing the unit cooler cover.
7. Carefully lower unit cooler cover to avoid damage to the fan wiring.

#### Install Unit Cooler Cover

1. Verify unit cooler wiring is connected and routed correctly.
2. Lift unit cooler cover into place. Front edge of the cover should be behind the unit cooler case.
3. Using a 5/16" socket wrench, install four screws to secure the unit cooler cover.
4. Insert drain hose through hole in the rear of the refrigerator.
5. Push drain hose upward, toward the unit cooler drain port.
6. In the chamber, attach drain hose to unit cooler drain port.
7. Reinstall top drawer, basket, or shelf if previously removed.
8. Seal the opening around the drain hose on the back of the unit using putty.
9. Switch AC ON/OFF switch ON. Switch battery switch ON.
10. Touch **Mute** to disable the high temperature alarm while refrigerator reaches operating temperature.

## 6 Troubleshooting

### CAUTION

Review all safety instructions prior to troubleshooting. Refer to Section 1.1.

### 6.1 General Operation Problems

Problem	Possible Cause	Action
A drawer or basket does not slide easily.	Debris in the drawer slides.	Pull the drawer or basket out and confirm the slides are free of debris. Clean if necessary.
	Drawer slides are not lubricated.	Using a lightweight oil, lubricate the bearings in the slides.
	Drawer or basket is misaligned or not level.	Confirm both slides for drawer or basket are mounted at the same height.
	Drawer slide is faulty.	Confirm the slide is operating correctly. Replace if necessary.
A door does not open easily.	Debris in hinges.	Confirm the hinges are free of debris. Clean the hinges if necessary.
	Hinge is faulty.	Confirm the hinge spring or pin is not damaged. Replace entire hinge (lower hinge only), if necessary.
	Lower hinge spring and/or pin may be bent or faulty.	Replace the entire lower hinge spring and pin assembly.
Monitor display is hard to read.	Screen brightness set too low.	Change the screen brightness.
The monitor is not responding.	Digital electronics are locked because of an interruption in power.	Reset the monitoring system.
"Probe Failure" is displayed on the monitor.	Monitor probe wiring is an open circuit.	Check continuity of probe wiring and connections. Secure connections if necessary.
		Confirm probe is providing resistance in the range of 86 $\Omega$ to 110 $\Omega$ . Replace probe if necessary.

### 6.2 Chamber Temperature Problems

Problem	Possible Cause	Action
The chamber temperature displayed is higher or lower than the actual temperature.	Monitor probe is not calibrated.	Check the chamber temperature calibration. Change the calibration if necessary.
	Connections for the monitor probe are loose.	Check the monitor probe connections. Secure the connections if necessary.
	Monitor probe wiring is an open circuit.	Check the continuity of the probe wiring. Replace the probe if necessary.
	Probe bottle is empty, or the amount of solution is too low.	Check the level of product simulation solution in the bottle. Clean and refill the bottle if necessary.
	Digital electronics are locked because of an interruption in power.	Reset the monitoring system.
	Monitor is not calibrated.	Confirm the monitor probe is reading correctly. Calibrate the monitor probe if necessary.
The chamber temperature meets an alarm condition, but the appropriate temperature alarm is not active.	Temperature alarm setpoint was changed.	Check the current setpoints for the temperature alarms. Change the setpoints if necessary.
The compressor runs continuously.	Refrigerator setpoint is set too low.	Confirm the setpoint is set within the operating range and change it if necessary.
	Temperature controller is faulty.	Confirm the temperature controller or monitor/control board is operating correctly. Replace it if necessary.
	Compressor starting relay is faulty.	Confirm the relay is operating correctly. Replace the relay if necessary.

Problem	Possible Cause	Action
The chamber temperature does not stabilize at the refrigerator setpoint.	Temperature controller is faulty.	Confirm the temperature controller or monitor/control board is operating correctly. Replace it if necessary.
	Condensing unit fan is not running.	Check the condensing unit fan connections. Replace the fan motor if necessary.
	Unit cooler fan is not running.	Check the voltage to the fan when door switch is activated. Replace the fan motor or door switch if necessary.
	Compressor motor has seized.	Replace the compressor.
	Refrigerant level is too low.	Check the refrigeration lines for leaks and repair them if necessary. Check the refrigerant level. Recharge the refrigerant if necessary.
	Compressor starting relay is faulty.	Confirm the relay is operating correctly. Replace the relay if necessary.
	Condenser grill is dirty.	Check the condenser grill. Clean it if necessary.
	Circulation in the chamber is not adequate.	Check if there are any items that may obstruct air flow and remove them if necessary.
	Ambient air temperature around the unit is too high.	Confirm refrigerator location meets requirements. Refer to operation manual.
	A component is faulty or internal connections are loose.	Contact Helmer Technical Service.

### 6.3 Alarm Activation Problems

Problem	Possible Cause	Action
The refrigerator is in an alarm condition, but alarms are not audible.	Alarm system is faulty.	Confirm the circuit board and line connections are functioning correctly.
	Control board is faulty.	Replace parts with those included in control board kit, or replace monitor/control board.
	Alarm buzzer is faulty.	Replace the alarm buzzer.
	A component is faulty or internal connections are loose.	Contact Helmer Technical Service.
	Audible alarms are muted.	Verify that audible alarms are not muted. If time remaining is greater than five minutes, change MUTE timer value to five minutes and wait until timer resets.
The refrigerator meets an alarm condition, but the appropriate alarm is not active.	Control board is faulty.	Replace parts with those included in the control board kit, or replace the monitor/control board.
	Alarm setpoint was changed.	Check the current setpoints for the alarms.
	A component is faulty or internal connections are loose.	Contact Helmer Technical Service.
The High Temperature alarm activates when the door is opened, then clears shortly after the door is closed.	Connections for the monitor probe are loose.	Check the monitor probe connections. Secure the connections if necessary.
	Monitor probe is faulty.	Test the probe. Replace the probe if necessary.
	Unit cooler fan continues to run while the door is open.	Test the door switch and unit cooler fan connections. Secure the connections if necessary. Replace the door switch or fan motor if necessary.
	Probe bottle is empty.	Check level of product simulation solution in bottle. Clean and refill bottle if necessary.
	High temperature alarm setpoint is set too low.	Check the setpoint. Change the setpoint if necessary.
	A component is faulty or internal connections are loose.	Contact Helmer Technical Service.
The refrigerator is connected to power, but the AC Power Failure alarm is active.	Outlet connection is faulty.	Verify power at the outlet. Repair the original outlet or connect to a different outlet if necessary.
	Power cord is faulty.	Confirm the power cord is connected securely. Secure the power cord if necessary.
	AC power switch located inside front lower panel is faulty.	Replace the ON/OFF AC power switch.
	AC power switch is OFF.	Turn AC power switch to the ON position.
	A component is faulty or internal connections are loose.	Contact Helmer Technical Service.
	Circuit breaker is tripped.	Reset or replace the circuit breaker.



Problem	Possible Cause	Action
The Door Open alarm is activating sporadically.	Door is not closing completely.	Clean hinges if debris is present.
		Confirm door is aligned.
		Confirm hinge spring and/or pin are not damaged. Replace hinge (lower only) if necessary.
	Door is closing but not sealing completely.	Confirm the door gasket seals completely. Replace the door gasket if necessary.
	Connections for the door switch are faulty.	Test the switch connections. Secure the connections if necessary.
	Door switch is faulty.	Replace the door switch.
	Control board is faulty.	Replace parts with those included in control board kit, or replace monitor/control board.
All alarms are activating sporadically.	Alarm system is faulty.	Confirm the circuit board and line connections are functioning correctly.
	Control board is faulty.	Replace parts with those included in control board kit, or replace monitor/control board.
	A component is faulty or internal connections are loose.	Contact Helmer Technical Service.
The condenser alarm is active.	Condenser temperature probe is faulty.	Test the probe. Replace the probe if necessary.
	Condenser fins are dirty.	Clean as necessary, or order new ones from Helmer or your distributor.
	Compressor is overheating due to a lack of air flow.	Check the condenser grill and clean if necessary.
		Confirm the refrigerator is correctly located. Refer to the operation manual.
	Condenser probe is not calibrated.	Confirm the condenser probe is reading correctly. Calibrate probe if necessary.
	Condenser alarm setpoint is too low.	Confirm the alarm setpoint is at the appropriate value.
	Condenser fan motor is faulty.	Replace the condenser fan motor.
A component is faulty or internal connections are loose.	Contact Helmer Technical Service.	
The No Battery alarm is activating sporadically.	Monitoring system back-up batteries voltage level is low.	Replace the back-up batteries for the monitoring system.

### 6.4 Testing Problems

Problem	Possible Cause	Action
The automatic temperature tests do not work.	Connections for the monitor probe are loose.	Test the monitor probe connections. Secure the connections if necessary.
	Monitor probe is faulty.	Test the monitor probe. Replace the probe if necessary.
	Control board is faulty.	Replace parts with those included in control board kit, or replace monitor/control board.
	High Alarm setpoint is set significantly higher than default value, or Low Alarm setpoint is set significantly lower than default value.	Confirm the alarm setpoints are set at the expected or correct values.
		Test the temperature alarms manually.
A component is faulty or internal connections are loose.	Contact Helmer Technical Service.	

## 6.5 Condensation Problems

Problem	Possible Cause	Action
There is excessive water in the water evaporation tray inside the lower compartment in the back of the unit.	Humid air is entering the chamber	Confirm the refrigerator is level, and the door is aligned, closing tightly, and sealing correctly. Correct issues as necessary.
There is excessive water in the chamber.	Humid air is entering the chamber.	Confirm the refrigerator is level, and the door is aligned, closing tightly, and sealing correctly. Correct issues as necessary.
	Connection between unit cooler and drain tube is loose.	Confirm the connection is secure. Tighten the connection if necessary.
	Drain line is plugged.	Confirm the drain tube is free of debris. Remove debris if necessary.
There is excessive moisture on the doors.	Humid air is entering the chamber.	Confirm the refrigerator is level, and the door is aligned, closing tightly, and sealing correctly.
	Relative humidity around refrigerator is too high.	Confirm refrigerator location meets requirements.
Water leaks from the bottom of the refrigerator.	Humid air is entering the chamber.	Confirm the refrigerator is level, and the door is aligned, closing tightly, and sealing correctly.
	Excessive water found in evaporation tray inside unit.	Contact Helmer Technical Service to correct issues as necessary.

## 7 i.Series Parts

### Notes

- Before replacing parts, protect items in refrigerator from extended exposure to adverse temperature.
- Allow refrigerator temperature to stabilize at setpoint after replacing parts or after extended door opening.
- Circuit boards are sensitive to static electricity and can be damaged by electrostatic discharge. Use proper ESD precautions when handling the display assembly.



i.Series Information

Letter	Description	Part Number	Model	Letter	Description	Part Number	Volts	Hz
A	Magnetic lock (optional Access Control) * = right hinged, left handle ** = left hinged, right handle	800139-1*	105	Not shown	Chart paper (52 sheets)	220366	-	-
		800286-1**	105		Chart recorder battery	120218	-	-
		800141-1*	104	F	Display assembly	800041-1	-	-
		800287-1**	104	Not shown	USB / Power cable for i.Center display	800010-1	-	-
B	Door handle (optional Access Control)	322000-1	-	G	Battery switch	120202	-	-
C	Low profile handle * = right hinged, left handle ** = left hinged, right handle	800891-1*	-	H	Monitoring system back-up battery	120628	-	-
		800891-2**	-	I	Main power switch	120478	-	-
Not shown	Door key * = Serial # 2041434 and prior	220460	-	J	Circuit breakers	120272	230	50
		220481	-	120288		230	60	
D	Caster - swivel with brake	220380	-	K	Battery key switch (optional Access Control)	401220-1	-	-
	Casters (includes 4 casters and hardware)	400819-2	-	L	Hinge assembly	220506	-	-
E	Temperature chart recorder	500612-1	-					

**⚠ CAUTION**

Disconnect unit from AC power when replacing LED lamps.

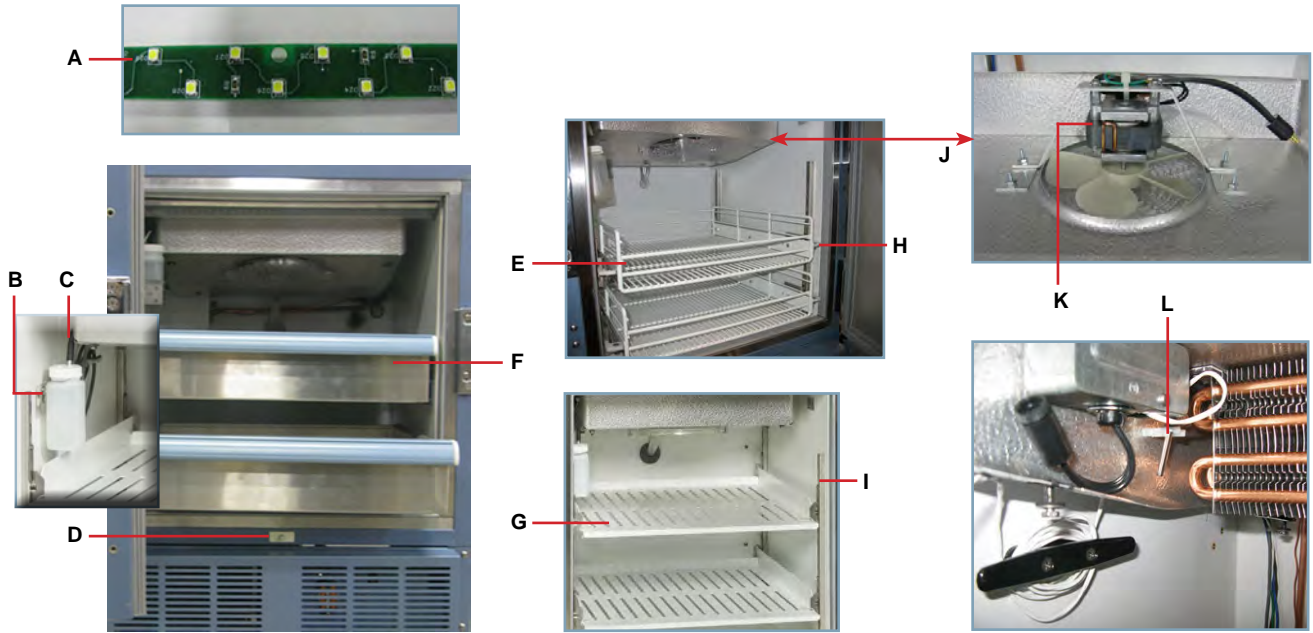

i.Series Information

Letter	Description	Part Number	Model	Letter	Description	Part Number	Volts
A	Light assembly (circuit board and cover)	800023-1	-	G	Full shelf (Lab/Pharmacy) * = Serial # 2041434 and prior	400914-1	-
B	Probe bottle and glycerin kit	400922-1	-			400814-1*	-
C	Primary monitor probe	800038-1	-	H	Slide assembly (drawer, basket)	400753-2	-
Not Shown	Chart recorder probe	800024-1	-	I	Standard (shelf, drawer, basket)	321173-1	-
D	Door switch	120380	-	J	Unit cooler assembly	800130-1	120
E	Roll out basket assembly (optional)	400815-1	105			800824-1	230
		401133-1	104	K	Unit cooler fan motor	800836-1	120
F	Drawer assembly (Blood Bank)	400752-3	105			800835-1	230
		401123-1	104	L	Control probe	800048-1	-

**⚠ CAUTION**

Disconnect unit from AC power before accessing the electrical tray.

**Note**

Circuit boards are sensitive to static electricity and can be damaged by electrostatic discharge. User proper ESD precautions when handling board.

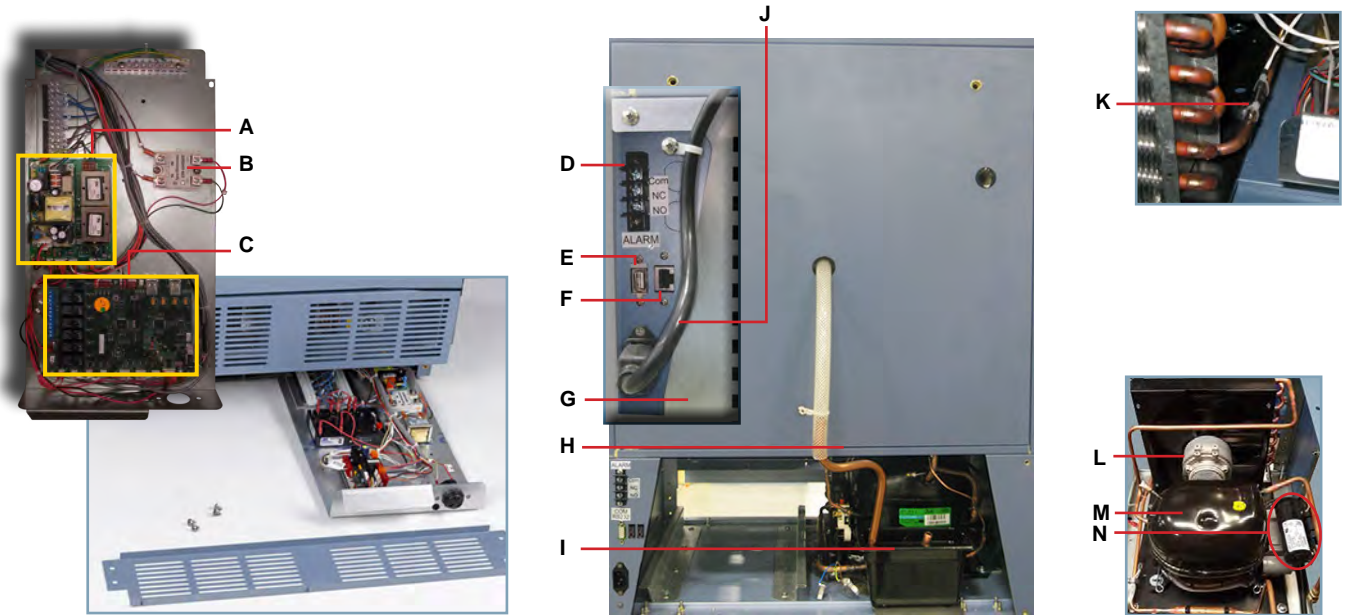

i.Series Information

Letter	Description	Part Number	Volts	Letter	Description	Part Number	Volts
A	Power supply board	800916-1	-	K	Condenser probe	400674-1	-
B	Solid state relay	800920-1	-	L	Condenser fan motor assembly (Embraco)	800905-1	115
C	i.C <sup>3</sup> control board	800034-4	-			800907-1	230
Not Shown	Power line filter	120299	-		Condenser fan motor assembly (Danfoss)	120787	115
	Compressor power line filter	120706	-		120609	230	
D	Remote alarm contact	-	-	M	Compressor (Embraco)	800912-1	115
E	USB port	120638	-			800913-1	230
F	RJ-45 Ethernet port	800008-1	-		Compressor (Danfoss)	800129-1	115
Not Shown	RS232 COM port (optional)	-	-		800022-2	230	
				N	Compressor start relay/start capacitor/ OLP kit (Embraco)	800904-1	115
G	Rear cover	321184-1	-			800906-1	230
H	Drain tube	321190-1	-		Not Shown	Compressor relay/capacitor kit (Danfoss)	800142-1
I	Condensate evaporator tray	-	-	Compressor relay (Danfoss)		120605	230
J	Power cable (with connector)	120630	115	Compressor capacitor (Danfoss)		120607	230
		120631	230				
	Power cable (European models)	120156	230				
	Power cable (Chinese models)	120547	230				
	Power cable (Saudi Arabian models)	120641	230				

## 8 Schematics

### 8.1 iB and iLR Models; 104 and 105 Configuration

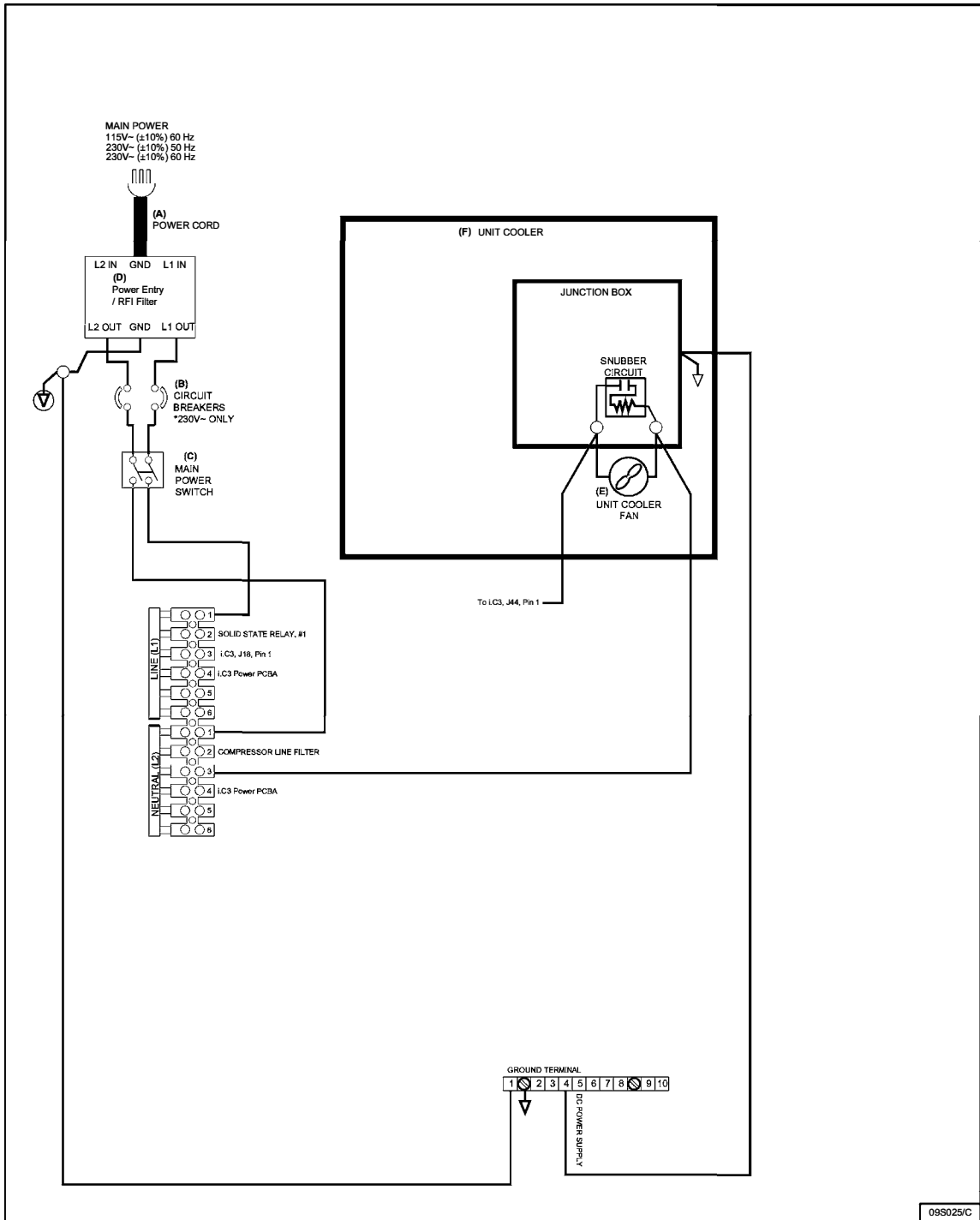

THESE DRAWINGS AND SPECIFICATIONS ARE THE SOLE PROPERTY OF HELMER INC. AND SHALL NOT BE REPRODUCED OR USED AS THE BASIS FOR MANUFACTURE OR SALES OF APPARATUS WITHOUT THE APPROVAL OF HELMER INC.

i.Series Information

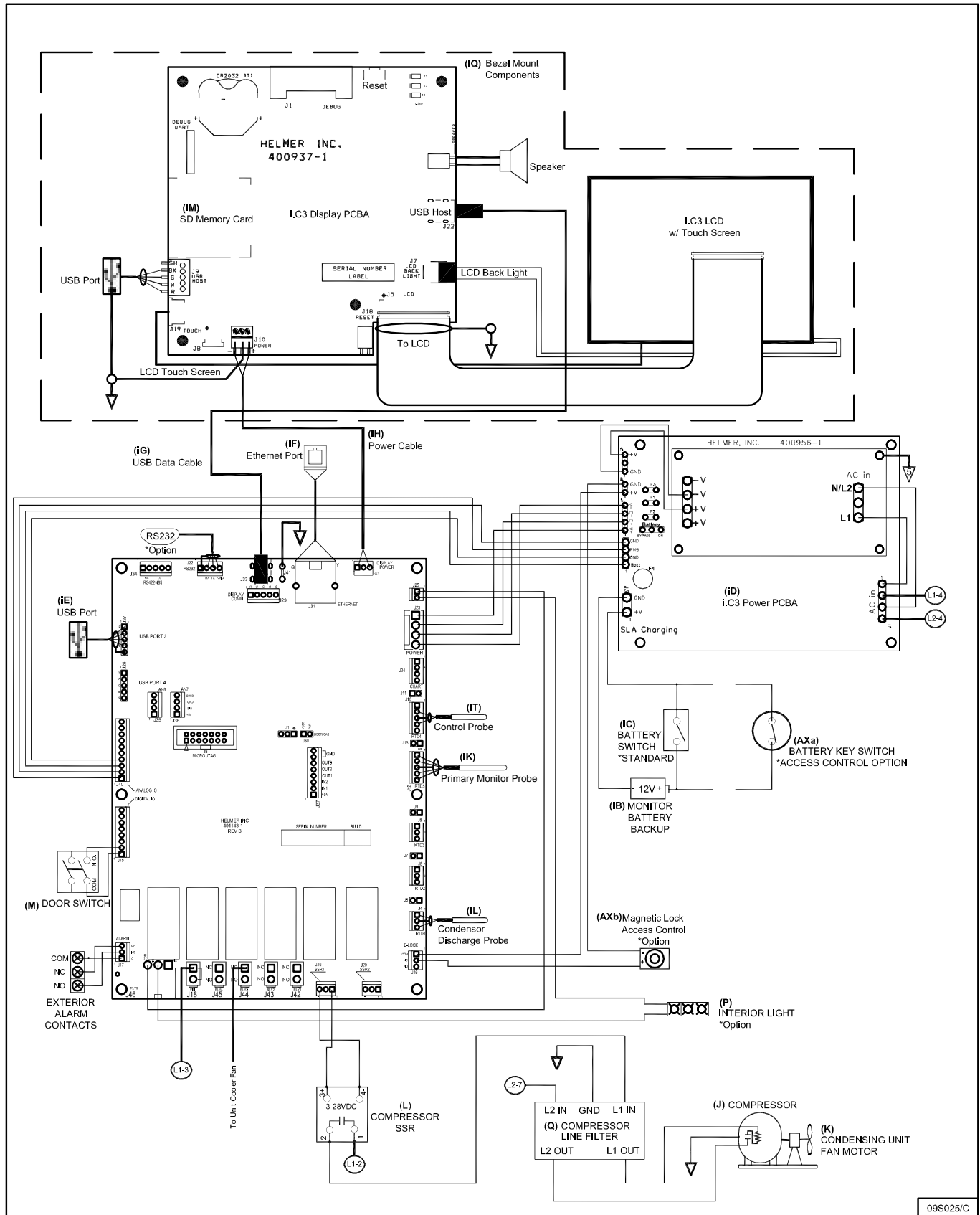

Horizon Series Information

These drawings and specifications are the sole property of Helmer Inc. and shall not be reproduced or used as the basis for manufacture or sales of apparatus without the approval of Helmer inc.

# Horizon Series Information

## 9 Installation and Configuration

### 9.1 Location Requirements

- ◆ Grounded outlet meeting the electrical requirements listed on the product specification label.
- ◆ Clear of direct sunlight, high temperature sources, and heating and air conditioning vents.
- ◆ Minimum 3" (76 mm) of space behind unit.
- ◆ Meets limits specified for ambient temperature (15°C to 32°C) and relative humidity.

### 9.2 Placement and Leveling

#### CAUTION

- To prevent tipping, ensure the casters (if installed) are unlocked and the door is closed before moving the refrigerator.
- Do not sit, lean, push or place heavy objects on top surface.

1. Move refrigerator into place. Lock casters if installed.
2. Ensure refrigerator is level.

#### Note

Helmer recommends the use of leveling feet (unless casters are installed) and wall and floor brackets (PN 400472-2) for stabilization. Contact Helmer Technical Service for parts and instruction.

### 9.3 Stacked Undercounter Units

#### CAUTION

- For stacked configuration, both units must have leveling feet installed.
- Back brace bars and front stabilizing brackets must be installed (Blue - PN 400821-1; Stainless Steel - PN 400821-2).
- When stacking units, place the heavier unit on the bottom.
- Do not open multiple loaded drawers or baskets at the same time.

Contact Helmer or your distributor for more information regarding the stacking kit and methods to secure both units to the wall and / or floor.

### 9.4 Connect Back-Up Power

The monitoring system has a back-up battery system, enabling a period of continuous operation if power is lost.

Battery life varies by manufacturer as well as voltage level remaining. Providing full battery power is available, back-up power for the monitoring system is available for up to two hours. Providing full power is available, back-up power for the optional Access Control system is available for up to 2.5 hours.

#### CAUTION

Before installing or replacing batteries, switch main power OFF and disconnect the refrigerator from AC power.

#### Notes

- The optional Access Control system uses an independent battery for back-up power.
- The monitoring system will start on back-up battery power alone. If the refrigerator was not previously connected to AC power and the back-up battery is connected, the monitoring system will begin running on battery power.
- If AC power is lost, the monitoring system will automatically disable some features to prolong back-up battery power. Data collection will continue until back-up battery power is depleted.



The monitoring system and optional Access Control back-up batteries are located below the chamber, behind the front panel. A panel cover must be removed to access the batteries.



Monitoring system back-up battery.

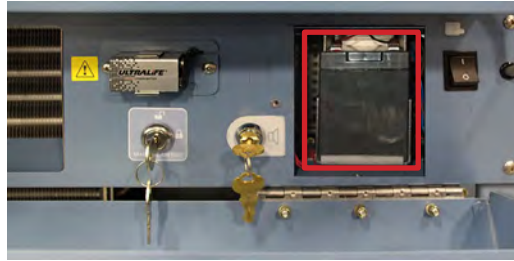

Optional Access Control back-up battery.

## 9.5 Prepare for Monitoring

Monitoring system back-up battery is included in the literature box. Install and connect the battery to provide monitoring system with back-up power in the event of AC power failure. If included, switch the Access Control back-up battery ON to provide the optional Access Control system with back-up power in the event of an AC power failure.

### Temperature Probes

#### Notes

- Temperature probes are fragile; handle with care.
- Remote probes may also be introduced through the existing rear port and immersed in existing probe bottle.

The probe bottle along with a container of glycerin have been provided with this unit. The glycerin is mixed with water to create a solution which simulates the product stored in the refrigerator. The product simulation solution temperature reflects the product's temperature during normal operation.

The probe bottle should contain 4 oz. (120 mL) of product simulation solution at a 10:1 ratio of water to glycerin.



Probe bottle with probe.

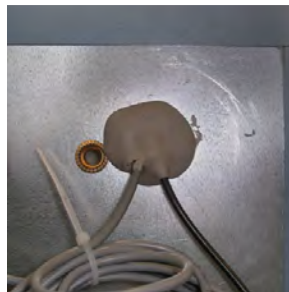

Rear access port.

#### Fill Probe Bottle

1. Remove all probes from bottle and remove bottle from bracket.
2. Remove cap and fill with 4 oz. (120 mL) of product simulation solution.
3. Install cap and place bottle in bracket.
4. Replace probes, immersing at least 2" (50 mm) in solution.

#### Install Additional Probe Through Top Port

1. Peel back putty to expose port.
2. Insert probe through port into chamber.
3. Insert probe into bottle.
4. Replace putty, ensuring a tight seal.

### Install Additional Probe Through Side Port

1. Remove interior and exterior plugs to expose side access port.
2. Insert probe through port into chamber.
3. Insert probe into bottle.
4. Ensure port is tightly sealed using putty.

### Chart Recorder (if included)

The chart recorder has a back-up battery system, enabling a period of continuous operation if power is lost. Battery life varies by manufacturer as well as voltage level remaining. Providing full power is available, back-up power for the temperature chart recorder is available for up to 14 hours.

#### Note

- If chart recorder has been operating on back-up battery power, the battery should be replaced to ensure the back-up source has proper charge.
- For complete information, refer to the Temperature Chart Recorder Operation and Service Manual included with this unit.

#### Prior to use:

Route the chart recorder probe through the rear access port and place in bottle with primary monitor probe.

#### Set up and Operation

Access chart recorder by pulling the door open.



### Install Battery

Connect the leads to the battery to provide back-up power to the chart recorder.

### Install / Replace Chart Paper

#### Note

- For accurate temperature reading, ensure the current time is aligned with the time line groove when chart knob is tightened.
- Contact Helmer Technical Service to reorder chart paper; part number 220366 (52 sheets).



Chart recorder stylus and time line groove

1. Press and hold **C** button. When stylus begins to move left, release button. The LED flashes.
2. When stylus stops moving, remove chart knob then move knob up and away.
3. Place chart paper on chart recorder.
4. Gently lift stylus and rotate paper so current time line corresponds to time line groove.
5. Hold chart paper in place while making sure the chart knob is fully tightened. (*Failure to fully tighten the knob can result in paper slipping and losing time.*)
6. Press and hold **C** button. When stylus begins to move right, release button.

7. Confirm stylus is marking on paper and stops at the correct temperature.
8. Calibrate chart recorder to match primary temperature if needed and close recorder door.

### External Monitoring Devices

The remote alarm interface is a relay switch with three terminals:

- ◆ Common (COM)
- ◆ Normally Open (NO)
- ◆ Normally Closed (NC)

Terminals are dry contacts and do not supply voltage. Interface circuit is either normally open or normally closed, depending on terminals used.

Requirements for your alarm system determine which alarm wires must connect to terminals.

#### CAUTION

- The interface on the remote alarm monitoring system is intended for connection to the end user's central alarm system(s) that uses normally open or normally closed dry contacts.
- If an external power supply exceeding 33 V (RMS) or 70 V (DC) is connected to the remote alarm monitoring system's circuit, the remote alarm will not function properly and may cause damage to the control board or result in injury to the user.

The terminals on the remote alarm interface have the following maximum load capacity:

- ◆ 0.5 A at 125 V (AC)
- ◆ 1 A at 250 V (DC)

#### Connect to Remote Alarm Interface

1. On the electrical box, locate the remote alarm terminals.
2. Connect remote alarm wires to appropriate terminals, according to requirements for your alarm system.
3. Use a cable tie to relieve strain on alarm wires (as necessary).

## 9.6 Configure Storage

#### CAUTION

- Before moving drawers, ensure they are completely empty for safe lifting.
- Maximum basket, drawer, or shelf load is 100 lbs (46 kg).

#### Note

Before moving storage components, protect stored items in refrigerator from extended exposure to adverse temperature.

### Product Loading Guidelines

When loading your refrigerator, take care to observe the following guidelines:

- ◆ Never load refrigerator beyond capacity.
- ◆ Always store items within shelves, drawers or baskets.
- ◆ Temperature uniformity is maintained by air circulation, which could be impeded if unit is overfilled, particularly at the top or back. Ensure proper clearance is provided below the fan.

#### Note

Products stacked against back wall may obstruct air flow and affect performance of unit.

## Drawers and Baskets

### Remove a Drawer or Basket

1. Pull drawer or basket out until it stops.
2. Tilt the front of the drawer or basket upward.
3. Pull drawer or basket free of the slides.

### Install a Drawer or Basket

1. Align end guides on drawer or basket with the slides.
2. Gently push drawer or basket into chamber until it stops.
3. Pull drawer or basket out until it stops; check for smooth operation.

### Move Drawer Slides

1. Using a screwdriver, remove bracket retainers.
2. Tap brackets upward to disengage standards.
3. Remove slides from standards
4. Insert slides into standard at appropriate height.
5. Tap brackets downward to engage standards.
6. Using a screwdriver, install bracket retainers.

## Shelves

### Remove a Shelf

1. With one hand, lift front edge of the shelf from the front brackets.
2. With the other hand, reach under the shelf and bump rear edge of the shelf upward to disengage rear brackets.

### Install a Shelf

1. Insert shelf into chamber, placing it on brackets.
2. Gently bump rear edge of the shelf downward to engage brackets.
3. Pulling shelf forward gently; shelf should not disengage from rear brackets.

### Move Shelf Brackets

1. Using a screwdriver, remove bracket retainers.
2. Tap brackets upward to disengage standards.
3. Remove brackets from standards.
4. Insert front brackets into standard at appropriate height.
5. Tap brackets downward to engage standards.
6. Using a screwdriver, install bracket retainers.

## 9.7 Optional Adapter Kits for Medication Dispensing Locks

Contact Helmer Technical Service or your distributor for service documentation pertaining to medication dispensing lock adapter kits.

## 9.8 Reverse Door Hinges and Handle

### Notes

- The following instructions apply to reversing a right-hinged door to a left-hinged door. Some steps will need to be reversed if changing from left-hinged to right-hinged.
- Door hinge and handle cannot be reversed on units equipped with Access Control.
- Unit must be on floor or an elevated work surface with adequate space to place door face-down in front of unit.
- To prevent personal injury and/or damage to the door, Helmer recommends two people for this procedure.

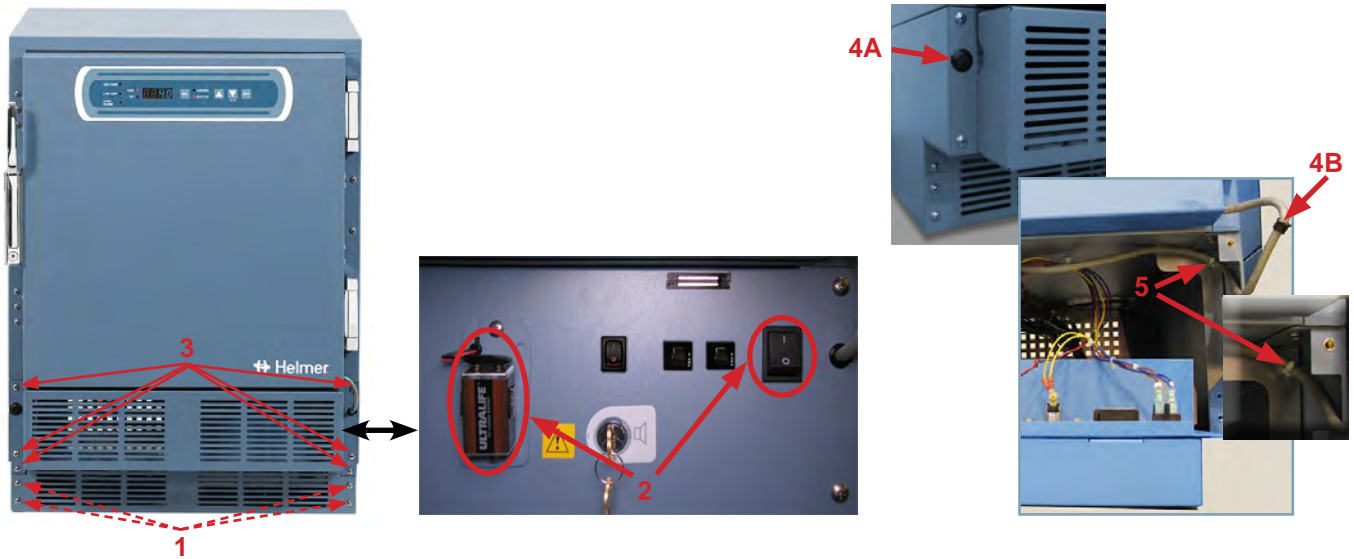

**Remove Door and Hinges**

1. With access panel cover closed, remove four screws securing the kick plate to the unit. Set kick plate and screws aside.
2. Open the front access panel and switch main power switch to OFF; disconnect back-up battery; disconnect AC power cord from power receptacle.
3. Remove six screws securing the access panel and cover to the unit and carefully place them in front of the unit ensuring there is no strain on the wiring.
4. Remove plug from access panel on handle-side of unit. Remove grommet from hole on hinged-side of unit and slide braided sleeve out of the slot.
5. Cut zip tie holding power cable inside the unit.

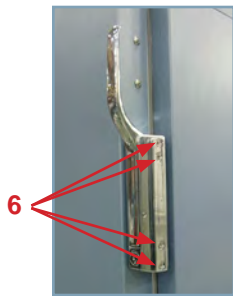

*Units with serial number 2041434 and prior*



or



*Units with serial number 2041435 and greater*



6. Remove screws securing door handle assembly to the door and set assembly aside.
7. Remove screws attaching the latch plate to the unit and set aside.

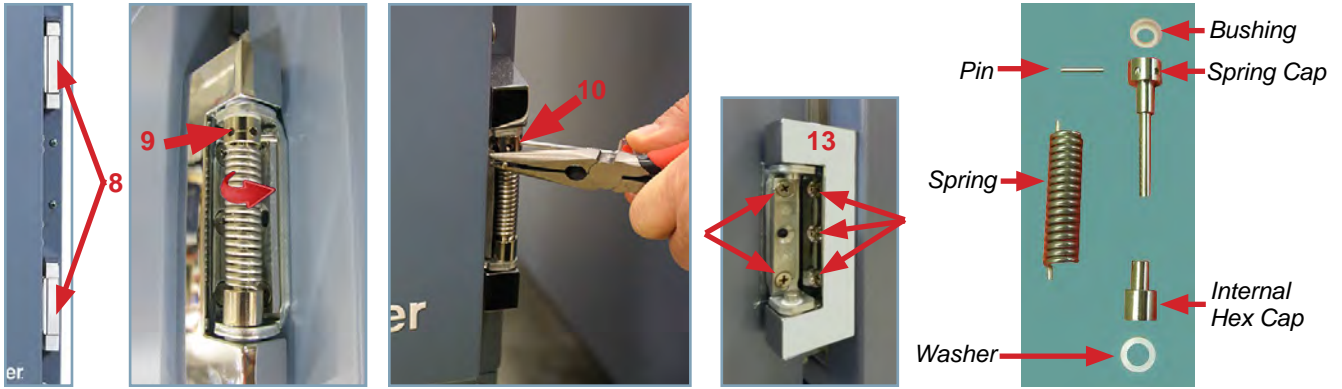

8. With door shut, remove cover plate from both hinges and note the orientation of the hinges.
9. Remove the lower hinge spring assembly using a punch or J-hook tool to engage the left-most hole in the spring cap and rotate the spring cap from left to right and hold.
10. Using needle-nose pliers, remove the pin from the spring cap and slowly release spring back to the left.
11. Using a punch or J-hook tool to engage any hole in the spring cap, compress spring downward.
12. Remove spring assembly from lower hinge and set aside.
13. Supporting the door, remove five screws attaching lower hinge to door and unit, and noting the size and location of each screw. Set the hinge aside.
14. Remove the five screws attaching the upper hinge to the door and unit, and noting the size and location of each screw. Set the hinge aside.

**Reroute Communication Cables**



1. Carefully place door face-down in front of the unit ensuring there is no strain on cables running from the cabinet to the door.
2. Remove the remaining screws from the door assembly. Using a punch or J-hook tool along the bottom edge, lift the inner door frame out of the outer door frame.
3. Remove the plug from the door on the handle-side and set aside.
4. Pull grommet out of hole in door on hinged-side and slide the braided sleeve out of the slot.

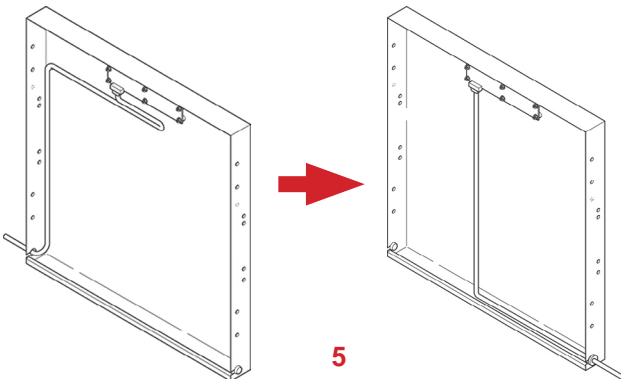

5. Reroute the data cable inside the door and out through the slot in the corner opposite from where the cable had

Horizon Series Information

previously exited the door. Cable should follow the bottom edge of the door frame.

6. Tape cable to the inside of the door ensuring any excess cable is on the outside of the door.
7. Cut zip ties securing the braided sleeve and slide the sleeve and grommets along the cables toward the door.
8. Slip cable through the slot in the door and insert the door-side grommet into the hole in the door.

#### Reassemble Door / Reverse Hinges

1. Reinstall inner door panel and secure with screws in holes opposite original configuration.
2. Reinstall hinges onto opposite side of door by reversing the orientation of the hinge plates and aligning holes in hinge plates with holes in door frame then hand-threading the two long screws in each hinge (leave screws slightly loose).
3. Lift door to cabinet and align holes in the hinge plates with the corresponding holes in the cabinet.
4. Hand-thread three short screws through each hinge and into cabinet ensuring the weight of the door does not rest on the hinges.
5. Level the door and tighten all screws securing hinges to the unit.
6. Reroute data cable across the front of the unit behind the access panel and secure with zip tie.
7. Slide the braided sleeve through the slot in the access panel allowing approximately 3" (76 mm) of slack between the door and the cabinet so door can open and close without straining cables. Install grommet in access panel.
8. Attach door handle on opposite side of door with four screws.
9. Attach strike plate and spacer to opposite side of unit with two screws. Test locking mechanism to ensure proper functionality.
10. With door closed, configure the hinge spring assembly for the opposite side of door.

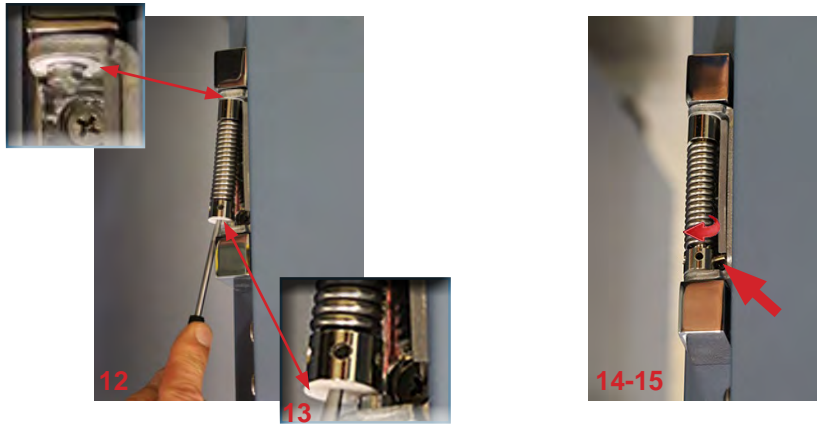

11. Orient the bend in the coil toward the front of the refrigerator and slide the internal hex cap with washer onto upper hex bolt in lower hinge plate.
12. Compress the spring upward using a punch or J-hook tool in the spring cap.
13. Slide the spring cap over the lower hex bolt in the lower hinge plate while compressing the spring.
14. Use a punch or J-hook tool to engage the right-most hole in the spring cap and rotate the spring cap from right to left, and hold.
15. Count four holes, beginning with and including the hole closest to the end of the coil, and insert the pin in the fourth hole.
16. Replace the hinge cover plates.
17. Reinstall access panel and cover securing with six screws.
18. Reinstall kick plate securing with four screws.
19. Plug power cord into power receptacle. Switch AC power switch ON. Reconnect back-up battery.
20. Verify door is level, hinges operate smoothly and door seals tightly.
21. Touch Mute to disable the high temperature alarm while refrigerator reaches operating temperature.

## 10 Controls

Horizon Series models are equipped with a monitor and optional control system which allows users to view and change current settings.

### 10.1 Monitor and Control Interface

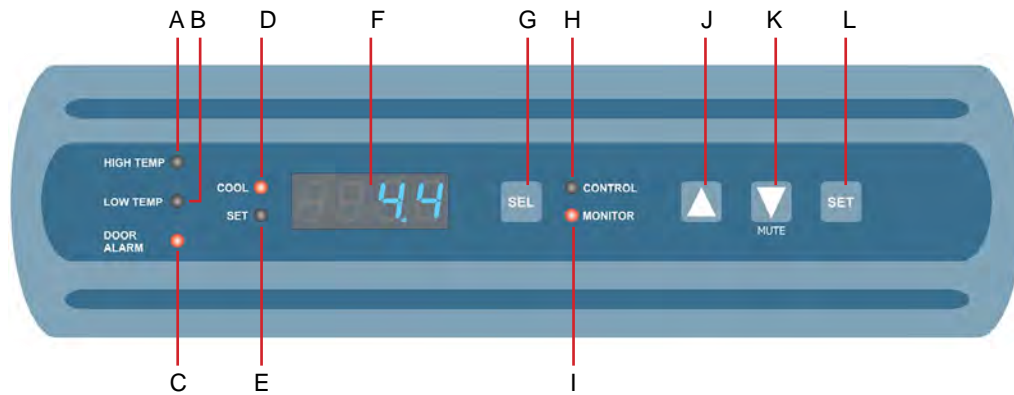

Table 9. Monitor and Control Indications

Label	Description	Function
A	HIGH TEMP lamp	Indicates when the refrigerator is in a high temperature alarm condition. Also indicates the high alarm temperature setpoint is being changed.
B	LOW TEMP lamp	Indicates when the refrigerator is in a low temperature alarm condition. Also indicates the low alarm temperature setpoint is being changed.
C	DOOR ALARM lamp	Indicates when the door is open.
D	COOL lamp	Indicates the compressor is running.
E	SET lamp	Indicates when temperature setpoint or alarm setpoint is being changed.
F	Display	Displays real-time temperature information, setpoints, and alarms.
G	SEL button	Toggles between alarm monitor and control modes.
H	CONTROL lamp	Indicates when the reading from the control probe is displayed.
I	MONITOR lamp	Indicates when the display is showing temperature readings from the monitor probe. Also indicates when alarm setpoints are being changed.
J	UP ARROW button	Increases a temperature setting.
K	DOWN ARROW / MUTE ALARM button	Decreases a temperature setting. Also mutes the audible alarm for 5 minutes.
L	SET button	Allows settings to be selected, prior to changing settings.

**Note**

The Alarm Disable key switch disables all audible alarms. This switch does not affect alarm lamps or signals sent through the remote alarm interface.

#### Display Minimum and Maximum Monitor Temperature Recordings

**Notes**

- This feature is standard on Horizon Series™ models with serial numbers of 2015494 or higher. Some exceptions may exist. For confirmation on your unit, please contact Helmer Technical Service.
- Units that do not include the minimum and maximum recording feature will not display .C or .F when entering the program mode. All temperature readings will appear in .C only.
- The following steps only apply to the primary monitor probe.

The minimum and maximum recording feature allows the user to view a minimum temperature occurrence and a maximum temperature occurrence within a given period of time. The timer provides a time reference in which those temperatures occurred.



 **View *Minimum* Temperature Recording.**

- ◆ Press and hold the **Down Arrow** button for 1 second and listen for a single beep. 
- ◆ The display will alternate between **LO** and a valid temperature value five (5) times followed by a single beep to indicate exit back to the temperature display.



 **View *Maximum* Temperature Recording.**

- ◆ Press and hold the **Up Arrow** button for 1 second and listen for a single beep. 
- ◆ The display will alternate between **HI** and a valid temperature value five (5) times followed by a single beep to indicate exit back to the temperature display.



 **View Recorded Temperature Timer.**

 **Notes**

- The timer denotes the period of time that has elapsed. It does not display the time at which a minimum or maximum temperature occurred.
- The maximum period of time the timer can record is 99:59 (99 hours and 59 minutes).

- ◆ Press and hold either the **Up** or **Down Arrow** button for 1 second.  or 
- ◆ While the display is flashing the **HI** or **LO** value, press and hold the **SET** button for 1 second.
- ◆ The display will alternate five (5) times between **CLr** and a value representing the number of hours and minutes that have elapsed since the last recording (example: 12:47 would represent 12 hours and 47 minutes). A single beep will follow to indicate exit back to temperature display.

 **Clear Minimum and Maximum Temperature Recordings.**

- ◆ Press and hold either the **Up** or **Down Arrow** button for 1 second.  or 
- ◆ While the display is flashing the **HI** or **LO** value, press and hold the **SET** button for 1 second and listen for a single beep.
- ◆ While the display is flashing the elapsed time since last reset, press and hold the **SET** button for 2 seconds. **CLr** will be displayed followed by a series of 3 beeps to indicate exit back to the temperature display.

 **Notes**

The minimum and maximum temperature and timer will reset when:

- the unit is powered off and battery back-up is not engaged, or
- after 99 hours and 59 minutes have elapsed.

## 10.2 Alarm Reference

If an alarm condition is met, an alarm activates. Some alarms are visual only; others are visual and audible. Some alarms are sent through the remote alarm interface.

The table indicates if an alarm is audible (A), visual (V), or sent through the remote alarm interface (R).

**Table 10. Alarm Indications**

Alarm	Alarm Type
High Temperature	A, V, R
Low Temperature	A, V, R
Door Open (Time)	A, V, R
Power Failure	A, V, R
Probe Failure	A, V, R

### 10.3 Settings

#### Temperature Setpoint

The default setpoint for the refrigerator is 4.0 °C. This can be changed if your organization requires a chamber temperature other than 4.0 °C.

#### Change Setpoint:

#### Note

The current temperature setpoint is typically higher than the chamber temperature.

1. On the monitoring system, press and release **SEL** to change to Control mode. The CONTROL lamp will illuminate.
2. Press and hold **SET** to display the current temperature setpoint.
3. Hold **SET** and press **Up or Down Arrow** as necessary to set the desired value.
4. Release **SET** button. The new setting is saved.
5. Press and release **SEL** to return to Monitor mode. The MONITOR lamp will illuminate.

#### Temperature Settings

Temperature settings are factory pre-set. Settings can be viewed and changed through the Monitor and Control interface.

**Table 11. Parameters, Indicators and Settings**

Parameter	Visual Indicator	Range	Default	
Celsius or Fahrenheit	TEMPERATURE UNITS, LED display	.C, .F	.C	
High Temperature	MONITOR Lamp & HIGH Lamp	-40.0 to 25.0 (°C) -40 to 77 (°F)	5.5 °C	
Low Temperature	MONITOR Lamp & LOW Lamp	-40.0 to 25.0 (°C) -40 to 77 (°F)	1.5 °C (HB); 2.0 °C (HLR & HPR)	
Monitor Offset	MONITOR Lamp only	-10.0 to 10.0 (°C) -18 to 18 (°F)	Varies	
Control Offset	CONTROL Lamp only	-10.0 to 10.0 (°C) -18 to 18 (°F)	Varies	
Hysteresis	CONTROL Lamp only <i>(units prior to serial number 2052029)</i>	0.5 to 2.5 (°C) 1 to 5 (°F)	<b>105 models</b>	<b>104 models</b>
	COOL Lamp only <i>(units with serial number 2052029 and greater)</i>		2.0 °C (120 V) 1.0 °C (120 V)* 1.0 °C (230 V)	1.2 °C 0.5 °C *

\* = low humidity models with serial numbers prior to 2047345

#### View Settings and Offset Values

1. Press and hold the **Up** and **Down Arrows** simultaneously for 3 seconds to enter program mode.
2. The LED Display will show .C or .F to indicate Celsius or Fahrenheit.
3. Press and release **SEL** to scroll through the parameters and view settings.
4. Hold **Up** and **Down Arrows** simultaneously for 3 seconds to exit program mode.
5. The LED Display will show current monitor temperature.

#### Temperature Units

#### Note

If temperature units are changed, the temperature setpoints, offsets and alarm settings must be recalibrated.

#### Select Temperature Units

1. Press and hold the **Up** and **Down Arrows** simultaneously for 3 seconds to enter program mode.
2. The LED Display will show .C or .F to indicate Celsius or Fahrenheit.
3. Press and hold the **SET** button while pressing the **Up** or **Down Arrow** to select the desired temperature unit parameter.
4. Release **SET** button. The new setting is saved.
5. Press and hold **Up** and **Down Arrows** simultaneously for 3 seconds to exit program mode.

Horizon Series Information

## Alarm Settings

The high and low temperature alarm settings may be changed by the operator. Temperature alarm setpoints specify the temperature at which an alarm activates. The setpoint for temperature alarms may be changed.

### High Temperature Alarm

#### Change the Alarm Setpoint

1. Press and hold the **Up** and **Down Arrows** simultaneously for 3 seconds to enter program mode.
2. The LED Display will show .C or .F to indicate Celsius or Fahrenheit.
3. Press **SEL** until HIGH TEMP and MONITOR lamps flash.
4. Hold **SET**, then press **Up** or **Down Arrow** to change the setpoint.
5. Release **SET** button. The new setting is saved.
6. Press and hold **Up** and **Down Arrows** simultaneously for 3 seconds to exit program mode.

### Low Temperature Alarm

#### Change the Alarm Setpoint

1. Press and hold the **Up** and **Down Arrows** simultaneously for 3 seconds to enter program mode.
2. The LED Display will show .C or .F to indicate Celsius or Fahrenheit.
3. Press **SEL** until LOW TEMP and MONITOR lamps flash.
4. Hold **SET**, then press **Up** or **Down Arrow** to change the setpoint.
5. Release **SET** button. The new setting is saved.
6. Press and hold **Up** and **Down Arrows** simultaneously for 3 seconds to exit program mode.

## Primary Monitor Probe

Verify the primary monitor probe is reading chamber temperature correctly by comparing primary monitor probe readings to the temperature measured by a calibrated reference thermometer. If the primary monitor probe is not reading correctly, change the monitor offset value displayed.

### Notes

- Ensure product simulation bottle is full of solution.
- The probe in the bottle is connected to the monitoring system and represents product storage temperature. This probe does not affect the refrigerator setpoint.

#### Calibrate Primary Monitor Probe:

1. Remove primary monitor probe from probe bottle.
2. Unscrew cap from the bottle and remove.
3. Attach a calibrated independent reference thermometer traceable per national standards to the primary monitor probe, and place them in the bottle. The probe and thermometer should be immersed at least 2" (50 mm).
4. Note the temperature on the calibrated reference thermometer and compare to the chamber temperature displayed on the monitor.
5. Adjust the monitor offset value higher or lower to reflect the difference between the chamber temperature displayed on the monitor and the temperature reading from the calibrated reference thermometer.
6. Remove reference thermometer from probe.
7. Replace the bottle cap, ensuring a tight fit.
8. Place primary monitor probe in bottle, immersing at least 2" (50 mm).

#### Enter the New Offset Value:

1. Press and hold the **Up** and **Down Arrows** simultaneously for 3 seconds to enter program mode.
2. The display will show .C or .F to indicate Celsius or Fahrenheit.
3. Press **SEL** until only the MONITOR lamp flashes.
4. Hold **SET**, then press **Up** or **Down Arrow** to change the monitor offset.
5. Release **SET** button. The new setting is saved.
6. Press and hold **Up** and **Down Arrows** simultaneously for 3 seconds to exit program mode.

### Control Sensor

The temperature controller senses unit cooler temperature through the control probe in the unit cooler. The unit cooler temperature typically varies from the chamber temperature, so an offset value is used by the control system to compensate for the difference.

The temperature controller adjusts chamber temperature around the refrigerator setpoint by activating the compressor when the control probe registers above the setpoint based on the hysteresis value.

#### Determine Control Sensor Offset:

##### Notes

- Control Sensor Offset is factory-preset and changing this value is not recommended. Contact Helmer Technical Service for questions regarding the Control Sensor Offset.

- View and record the Refrigerator Setpoint. (Reference Section 10.3)
- Allow the unit to run with calibrated monitor temperature for several compressor cycles, and record the average monitor temperature. *(If the monitor temperature remains close to the refrigerator setpoint no further action is needed.)*
- View and record the current Control Offset value.
- Subtract the Refrigerator Setpoint from the average monitor temperature and record the difference.
- Add the current Control Offset value to the recorded difference determined in the previous step to establish the new Control Offset value.

Example 1	Example 2
Refrigerator setpoint is 4.0	Refrigerator setpoint is 4.0
Average monitor temperature is 5.2	Average monitor temperature is 2.8
Current Control Offset is 0.3	Current Control Offset is 0.3
Subtract: $5.2 - 4.0 = 1.2$ ; difference between average temperature and setpoint.	Subtract: $2.8 - 4.0 = -1.2$ ; difference between average temperature and setpoint.
Add: $0.3 + 1.2 = 1.5$ ; new control offset value	Add: $0.3 + (-1.2) = -0.9$ ; new control offset value

#### Enter the New Offset Value:

##### Notes

- Ensure Control Sensor Offset is being changed, and not Hysteresis.
- Control Sensor Offset and Hysteresis have the same visual indicator.

- Press and hold the **Up** and **Down Arrows** simultaneously for 3 seconds to enter program mode.
- The Display will show .C or .F to indicate Celsius or Fahrenheit.
- Press **SEL** until only the CONTROL lamp flashes.
- Hold **SET**, then press **Up** or **Down Arrow** to change the setpoint.
- Release **SET** button. The new setting is saved.
- Press and hold **Up** and **Down Arrows** simultaneously for 3 seconds to exit program mode.

### Hysteresis

Hysteresis is the allowable temperature control variance on each side of the refrigerator setpoint.

##### Note

The Hysteresis value is factory-preset and should not be changed unless directed by Helmer Technical Service.

### Non-Configurable Alarms

The Power Failure and Door Open alarms indicate operational conditions which may require the attention of the operator or a qualified service technician. The Power Failure alarm will activate immediately upon loss of power. The Door Open alarm will activate once the door has remained open for approximately three minutes. These settings are factory-preset and may not be changed.

## 11 Maintenance

Maintenance tasks should be completed according to the schedule below. Refer to the service manual and the i.C<sup>3</sup> User Guide for more detail on the various tasks.

 **CAUTION**

- Review all safety instructions prior to recharging refrigerant. Refer to **Section 1.1**(Safety).
- Maintenance should only be performed by trained refrigeration technicians.

 **Notes**

- The preventive maintenance schedule provides recommended minimum requirements. Regulations or physical conditions at your organization may require maintenance items to be performed more frequently, or only by designated service personnel.
- Before performing maintenance, protect items in refrigerator from extended exposure to adverse temperature.
- Allow refrigerator temperature to stabilize at setpoint after performing service or after extended door opening.

**Table 11. Horizon Series Preventive Maintenance Schedule**

Task	Frequency			
	Quarterly	1 year	2 years	As Needed
Test the high and low temperature alarms.	✓			
Test the power failure alarm (as required by your organization's protocols).	✓			
Test the door alarm (as required by your organization's protocols).				✓
Check the temperature calibration on the monitor and change it if necessary.	✓			
Replace the monitoring system back-up battery.		✓		
Check the level of the solution in the probe bottles. Refill or replace solution if necessary.				✓
Examine the probe bottles and clean or replace if necessary.		✓		
Check the chamber lights and replace them if necessary.				✓
Clean the condenser grill.	✓			
Clean the door gaskets, interior, and exterior of the refrigerator.				✓
<b>Electrical compartment:</b> <ul style="list-style-type: none"> <li>• Inspect electrical components and wiring terminal strips for discoloration. Contact Helmer Technical Service if found.</li> <li>• Inspect wiring terminal strips for secure connections. Tighten connections as necessary.</li> </ul>	✓			
<b>Models with Access Control</b> Test the Access Control battery.	✓			
Replace the Access Control back-up battery.			✓	
<b>Models with chart recorders</b> Check the back-up battery for the chart recorder after an extended power failure and change it if necessary, or change the battery if it has been in service for one year. Refer to the Temperature Chart Recorder Operation and Service Manual.				✓

 **NOTICE**

Clean the condenser grill on a quarterly basis.

 **Note**

During a power failure the back-up battery provides power to the monitoring system, power failure alarm, and optional Access Control. If the back-up battery is not functioning, the power failure alarm will not be activated and the battery should be replaced.

## 11.1 Alarm Tests

Alarms should be tested to ensure they are working correctly. The refrigerator has alarms for chamber temperature, power failure, and door open (time).

### Chamber Temperature Alarm Test

#### NOTICE

- Perform the low alarm test before the high alarm test to control the temperature more closely and complete the testing more quickly.
- Before testing alarms, protect items stored in the unit from extended exposure to adverse temperature.
- Temperature probes are fragile; handle with care.

#### Test the Low Alarm:

1. Identify setting for low alarm setpoint.
2. Remove primary monitor probe from bottle.
3. Immerse probe in glass filled with water and crushed ice mixture.
4. When low temperature alarm sounds, note the temperature on the LED display.

#### Test the High Alarm:

1. Identify setting for high alarm setpoint
2. Immerse probe in glass of lukewarm water.
3. When high temperature alarm sounds, note the temperature on the LED display.
4. Remove probe from warm water.
5. Place primary monitor probe in probe bottle, immersing it at least 2" (50 mm).

### Power Failure Alarm Test

#### Note

During a power failure, the back-up battery should continue to provide power to the monitoring system.

1. Switch AC ON/OFF switch OFF. Audible power failure alarm will activate immediately and "PoFF" (power off) will appear on the display.
2. Switch AC ON/OFF switch ON. Audible power failure alarm will cease and "PoFF" will clear from the display.

### Door Open Alarm Test

#### Note

Factory-set to three minutes and can not be changed.

1. Open refrigerator door and note the time.
2. After three minutes, audible alarm will activate and DOOR ALARM lamp will flash.
3. Close refrigerator door. Audible door open alarm will cease and DOOR ALARM lamp will stop flashing.

## 11.2 Test and Replace Back-up Batteries

### Check Monitoring System Battery

The monitoring system does not indicate the charge level of the battery. Regularly test the battery and replace battery if the test fails or if the battery has been in use for one year.

 **Note**

Use only a battery which meets manufacturer's specifications.

 **Test the Battery:**

1. Switch the AC ON/OFF switch OFF.
2. Display should continue to display information.
3. If the display is blank, replace battery.
4. Switch AC ON/OFF switch ON.

### Check Optional Access Control System Battery

During an AC power failure, the Access Control back-up battery provides back-up power to the magnetic Access Control lock. Test the Access Control back-up battery to ensure it is working properly.

 **Test the Battery:**

1. Ensure Access Control back-up battery key switch is switched ON.
2. Switch AC ON/OFF switch OFF.
3. Verify "PoFF" (power failure) message is displayed.
4. Attempt to open the cabinet door, if the door remains locked, the battery is functional. If the door does not remain locked, replace the battery.
5. Switch AC ON/OFF switch ON.

### Chart Recorder Back-up Battery (if included)

Refer to 360076-1 Temperature Chart Recorder Operation and Service Manual.

## 11.3 Check Probe Bottle

Remove the probe bottle from the bracket and inspect for cracks. Replace the bottle if necessary.

Ensure the probe bottle has approximately 4 oz. (120 mL) of product simulation solution (10:1 ratio of water to glycerin). The glycerin is mixed with water to create a solution which simulates the product stored in the refrigerator. The product simulation solution temperature reflects the product's temperature during normal operation. Failure to fill the bottle may prevent the chamber temperature from stabilizing at the temperature setpoint. The probe should be immersed at least 2" (50 mm).

## 11.4 Clean the Refrigerator

### Cabinet Exterior

Clean glass surfaces with soft cotton cloth and glass cleaner. Clean exterior surfaces with soft cotton cloth and non-abrasive liquid cleaner.

 **CAUTION**

The condensate evaporator and water evaporation tray are hot.

### Cabinet Interior

Clean painted surfaces with mild detergent. Clean stainless steel surfaces with a general-purpose laboratory cleaner suitable for stainless steel.

## Condenser Grill

### CAUTION

Disconnect refrigerator from AC power when cleaning condenser grill.

If the refrigerator is located in an environment where it is exposed to excessive lint or dust, the condenser grill may require cleaning more frequently than stated in preventive maintenance schedule.

Clean the condenser grill using a soft brush and a vacuum cleaner.

## Door Gaskets

Clean with soft cloth and mild soap and water solution.

## Probe Bottles

### Clean and Refill Probe Bottles

1. Remove all probes from bottle.
2. Remove bottle from bracket and empty any remaining solution.
3. Clean bottle with a 1:9 ratio of bleach to water solution or a company approved equivalent oxidizing cleaner/disinfectant.
4. Refill bottle with 4 oz. (120 mL) of product simulation solution (10:1 ratio of water to glycerin).
5. Cap bottle tightly to minimize evaporation.
6. Place bottle in bracket.
7. Replace probes, immersing at least 2" (50 mm).



## 12 Service

### 12.1 Refrigerant

 **CAUTION**

- Review all safety instructions prior to recharging refrigerant. Refer to Section 1.1.
- Maintenance should only be performed by trained refrigeration technicians.

 **Notes**

- Use only non-CFC R134A refrigerant.
- Pressure readings may vary based on chamber temperature and ambient air temperature.
- Normal low side pressures are 16 psi to 18 psi when unit is functioning at standard operating temperatures and measured at the end of the compressor cycle.
- If a refrigerant leak is suspected, Helmer recommends finding and fixing the leak prior to recharging the unit.

Full initial refrigerant charge varies by size of compressor and date of manufacture. Applicable charge values are found in Table 12.

**Table 12. Refrigerant Charge**

Horsepower	Refrigerant	Initial Charge	Serial Number
1/4	R134A	9.5 oz. (269 g)	less than 2004753
1/6	R134A	4.5 oz. (128 g)	2004753 and greater

### 12.2 Replace LED Lamps

1. Switch AC ON/OFF switch OFF. Disconnect the battery.
2. Using a screwdriver, remove lamp strip from chamber.
3. Unsnap the defective LED and disconnect wires.
4. Snap new LED onto the lamp strip.
5. Connect the wires.
6. Using a screwdriver, attach lamp strip to chamber wall.
7. Switch AC ON/OFF switch ON. Reconnect the battery.
8. Press the MUTE button to disable the high temperature alarm while refrigerator reaches operating temperature.

### 12.3 Remove / Replace Unit Cooler Cover

The unit cooler cover must be removed when service to the control probe, fan motor(s) or coil is performed.

#### NOTICE

If unit cooler cover is not removed as detailed in this procedure the drain port may be damaged. Improper drainage may result in excessive icing and refrigerator's inability to maintain temperature.

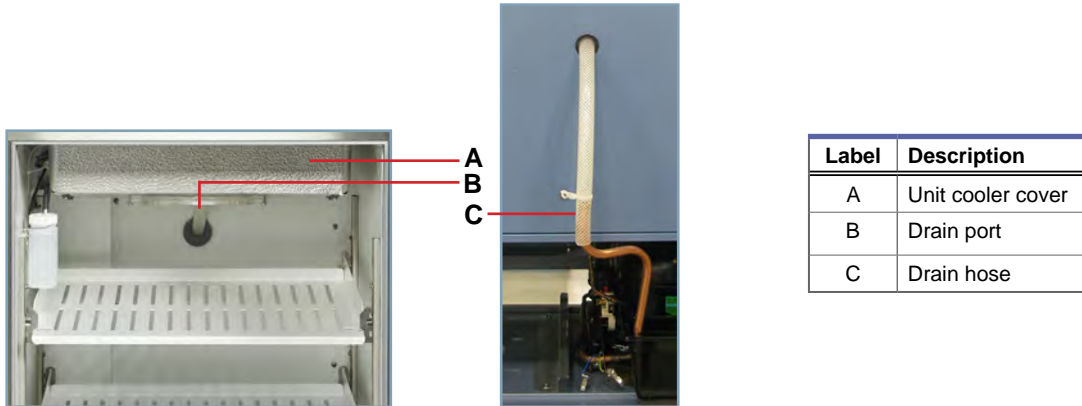

Drain line and hose.

#### Remove the Unit Cooler Cover

#### CAUTION

The condensate evaporator and water evaporation tray are hot.

1. Switch AC ON/OFF switch OFF. Disconnect the back-up battery.
2. Remove top drawer, basket, or shelf from the chamber.
3. On the back of the chamber, peel putty back to expose drain hose.
4. Pull drain hose downward while gently twisting to remove from unit cooler drain port.
5. Push drain hose out through rear of chamber.
6. Hold unit cooler cover in place to prevent dropping. Using a 5/16" socket wrench, remove four screws securing the unit cooler cover.
7. Carefully lower unit cooler cover to avoid damage to the fan wiring.

#### Install the Unit Cooler Cover

1. Verify unit cooler wiring is connected and routed correctly.
2. Lift unit cooler cover into place. Front edge of the cover should be behind the unit cooler case.
3. Using a 5/16" socket wrench, install four screws to secure the unit cooler cover.
4. Insert drain hose through hole in the rear of the refrigerator.
5. Push drain hose upward, toward the unit cooler drain port.
6. In the chamber, attach drain hose to unit cooler drain port.
7. Reinstall top drawer, basket, or shelf if previously removed.
8. On the back of the chamber, press putty around the drain hose.
9. Switch AC ON/OFF switch ON. Switch battery switch ON.
10. Touch **Mute** to disable the high temperature alarm while refrigerator reaches operating temperature.

## 13 Troubleshooting

 **CAUTION**

Review all safety instructions prior to troubleshooting. Refer to Section 1.1.

### 13.1 General Operation Problems

Problem	Possible Cause	Action
A drawer or basket does not slide easily.	Debris in the drawer slides.	Pull the drawer or basket out and confirm the slides are free of debris. Clean if necessary.
	Drawer slides are not lubricated.	Using a lightweight oil, lubricate the bearings in the slides.
	Drawer or basket is misaligned or not level.	Confirm both slides for the drawer or basket are mounted at the same height.
	Drawer slide is faulty.	Confirm the slide is operating correctly. Replace if necessary.
A door does not open easily.	Debris in the hinges.	Confirm the hinges are free of debris. Clean the hinges if necessary.
	Hinge is faulty.	Confirm the hinge spring or pin is not damaged. Replace entire hinge (lower hinge only), if necessary.
	Lower hinge spring and/or pin may be bent or faulty.	Replace the entire lower hinge spring and pin assembly.

### 13.2 Chamber Temperature Problems

Problem	Possible Cause	Action
"Prob" appears on the display, but the chamber temperature is set correctly.	Connections for the monitor probe are loose.	Test the probe connections. Secure the connections if necessary.
	Monitor probe wiring is an open circuit.	Check the continuity of the probe wiring and connections. Secure the connections or replace the probe if necessary.
	A component is faulty.	Contact Helmer Technical Service.
The chamber temperature meets an alarm condition, but the appropriate temperature alarm is not active.	Temperature alarm setpoint was changed.	Check the current setpoints for the temperature alarms. Change the setpoints if necessary.
The compressor runs continuously.	Refrigerator setpoint is set too low.	Confirm the setpoint is set within the operating range and change it if necessary.
	Control probe in the unit cooler is faulty.	Confirm the control probe is providing resistance in the range of 98 Ω to 110 Ω. Replace the probe if necessary.
	Monitor/control board is faulty.	Confirm the temperature controller or monitor/control board is operating correctly. Replace it if necessary.
	Compressor starting relay is faulty.	Confirm the relay is operating correctly. Replace the relay if necessary.
	Defrost timer is faulty.	Replace the defrost timer.

Problem	Possible Cause	Action
The chamber temperature does not stabilize at the refrigerator setpoint.	Monitor/control board is faulty.	Confirm the temperature controller or monitor/control board is operating correctly. Replace it if necessary.
	Compressor starting relay is faulty.	Confirm the relay is operating correctly. Replace the relay if necessary.
	Temperature monitor/controller board is faulty.	Confirm the temperature monitor/controller board is operating correctly. Replace the board if necessary.
	Condensing unit fan is not running.	Check the condensing unit fan connections. Replace the fan motor if necessary.
	Unit cooler fan is not running.	Check the voltage to the fan when door switch is activated. Replace the fan motor or door switch if necessary.
	Compressor motor has seized.	Replace the compressor.
	Control probe is out of calibration.	Confirm the probe is providing accurate temperature readings.
	Control probe is faulty.	Confirm the probe is providing resistance in the range of 98 Ω to 110 Ω. Replace the probe if necessary.
	Refrigerant level is too low.	Check the refrigeration lines for leaks and repair them if necessary. Check the refrigerant level. Recharge the refrigerant if necessary.
	The probe bottle is empty.	Refill the probe bottle.
	Condenser grill is dirty.	Check the condenser grill. Clean the grill if necessary.
	Air circulation at top of chamber is not adequate.	Check if there are any items that may obstruct air flow and remove them if necessary.
	Ambient air temperature around unit is too high.	Confirm the refrigerator is placed appropriately.
	A component is faulty or internal connections are loose.	Contact Helmer Technical Service.

### 13.3 Alarm Activation Problems

Problem	Possible Cause	Action
The refrigerator is in an alarm condition, but the appropriate alarm is not audible or active.	Alarm system is faulty.	Confirm the circuit board and line connections are functioning correctly.
	Monitor/control board is faulty.	Replace parts with those included in the control board kit, or replace the monitor/control board.
	Alarm buzzer is faulty.	Replace the alarm buzzer.
	A component is faulty or internal connections are loose.	Contact Helmer Technical Service.
	Alarm Disable key is in the OFF position.	Turn the Alarm Disable key to the ON position.
	Audible alarms are muted.	Verify that audible alarms are not muted.
	Alarm setpoint was changed.	Check the current setpoints for the alarms.
The High Temperature alarm activates when the door is opened, then clears shortly after the door is closed.	Connections for the monitor probe are loose.	Test the monitor probe connections. Secure the connections if necessary.
	Monitor probe is faulty.	Test the probe. Replace the probe if necessary.
	Unit cooler fan continues to run while the door is open.	Test the door switch and unit cooler fan connections. Secure the connections if necessary. Replace the door switch or fan motor if necessary.
	Probe bottle is empty.	Check level of product simulation solution in bottle. Clean and refill bottle if needed.
	High temperature alarm setpoint is set too low.	Check the setpoint. Change the setpoint if necessary.
	A component is faulty or internal connections are loose.	Contact Helmer Technical Service.

Horizon Series Information

Problem	Possible Cause	Action
The refrigerator is connected to power, but the AC Power Failure alarm is active.	Outlet connection is faulty.	Verify power at the outlet. Repair the original outlet or connect to a different outlet if necessary.
	Power cord is faulty.	Confirm the power cord is connected securely. Secure the power cord if necessary.
	AC power switch located inside front lower panel is faulty.	Replace AC power switch.
	AC power switch is OFF.	Turn the ON/OFF AC power switch to the ON position.
	A component is faulty or internal connections are loose.	Contact Helmer Technical Service.
	Circuit breaker is tripped.	Reset or replace the circuit breaker.
The Door Open alarm is activating sporadically.	Door is not closing completely.	Clean hinges if debris is present.
		Confirm door is aligned.
		Confirm hinge spring and/or pin are not damaged. Replace lower hinge if necessary.
	Door is closing but not sealing completely.	Confirm the door gasket seals completely. Replace the door gasket if necessary.
	Connections for the door switch are faulty.	Test the switch connections. Secure the connections if necessary.
	Door switch is faulty.	Replace the door switch.
	Monitor/control board is faulty.	Replace parts with those included in the control board kit, or replace the monitor/control board.
	A component is faulty or internal connections are loose.	Contact Helmer Technical Service.
All alarms are activating sporadically.	Alarm system is faulty.	Confirm the circuit board and line connections are functioning correctly.
	Monitor/control board is faulty.	Replace parts with those included in the control board kit, or replace the monitor/control board.
	A component is faulty or internal connections are loose.	Contact Helmer Technical Service.
	Condenser probe is not calibrated.	Contact a qualified service technician to confirm the condenser probe is reading correctly and to calibrate the probe if necessary.
An alarm activated, but temperature recorded at activation does not match alarm setpoint.	Temperature changed slightly around the time of activation.	No action necessary.

### 13.4 Condensation Problems

Problem	Possible Cause	Action
There is excessive water in the water evaporation tray inside the lower compartment in the back of the unit.	Humid air is entering the chamber.	Confirm the refrigerator is level, and the door is aligned, closing tightly, and sealing correctly. Correct issues as necessary.
There is excessive water in the chamber.	Humid air is entering the chamber.	Confirm the refrigerator is level, and the door is aligned, closing tightly, and sealing correctly. Correct issues as necessary.
	Connection between unit cooler and drain tube is loose.	Confirm the connection is secure. Tighten the connection if necessary.
	Defrost timer bypass switch may be in the ON position.	Check the defrost timer bypass switch on the circuit board. If in the ON position, switch to the OFF position. If the problem persists, then replace the defrost timer.
	Drain line is plugged.	Confirm the drain tube is free of debris. Remove debris if necessary.
There is excessive moisture on the doors.	Humid air entering chamber.	Confirm refrigerator is level, and door is aligned, closing tightly, and sealing correctly.
	Relative humidity around unit is too high.	Confirm refrigerator location meets requirements.
Water leaks from the bottom of the refrigerator.	Humid air is entering the chamber.	Confirm refrigerator is level, and door is aligned, closing tightly, and sealing correctly.
	Excessive water is found in the evaporation tray inside the refrigerator.	Contact Helmer Technical Service to correct issues as necessary.

## 14 Horizon Series Parts

### Notes

- Before replacing parts, protect items in refrigerator from extended exposure to adverse temperature.
- Allow refrigerator temperature to stabilize at setpoint after replacing parts or after extended door opening.
- Circuit boards are sensitive to static electricity and can be damaged by electrostatic discharge. Use proper ESD precautions when handling the board.

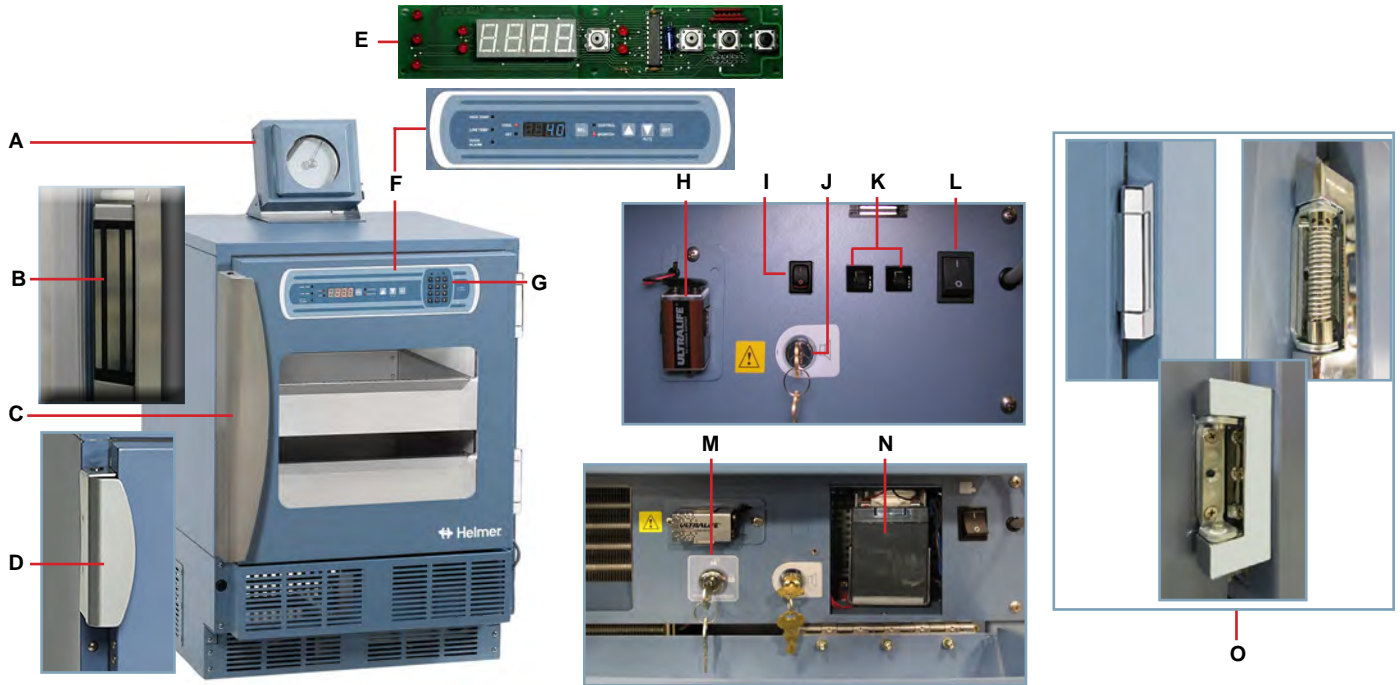

Letter	Description	Part Number	Model	Letter	Description	Part Number	Volts	Hz
A	Temperature chart recorder	500612-1	-	E	Display circuit board assembly	800031-1	-	-
Not shown	Chart paper (52 sheets)	220366	-	F	Membrane (without Access Control)	370106-1	-	-
	Chart recorder battery	120218	-		Membrane (with optional Access Control keypad)	320127-1	-	-
B	Magnetic lock (optional Access Control) * = right hinged ** = left hinged	800139-1*	105	Not shown	Interface cable (without Access Control)	400805-2	-	-
		800286-1**	105	G	Access Control keypad	800007-1	-	-
		800141-1*	104	H	Monitoring system back-up battery	120399	-	-
		800287-1**	104	I	Chamber light switch (optional)	120202	-	-
C	Door handle (optional Access Control)	322000-1	-	J	Alarm display key switch	120227	-	-
D	Door handle * = right handle; ** = left handle	800891-1*	-	K	Circuit breakers	120272	230	50
		800891-2**	-			120288	230	60
Not shown	Door key * = Serial # 2041434 and prior	220460	-	L	AC power switch	120478	-	-
		220481*	-	M	Back-up battery key switch (optional Access Control)	401220-1	-	-
	Caster - swivel with brake	220380	-	N	Back-up battery (optional Access Control)	120628	-	-
	Casters (includes 4 casters and hardware)	400819-2	-	O	Hinge assembly	220506	-	-

**⚠ CAUTION**

Disconnect unit from AC power when removing and replacing LED lamps.

**i Note**

The chamber light is optional on Horizon Series refrigerators.

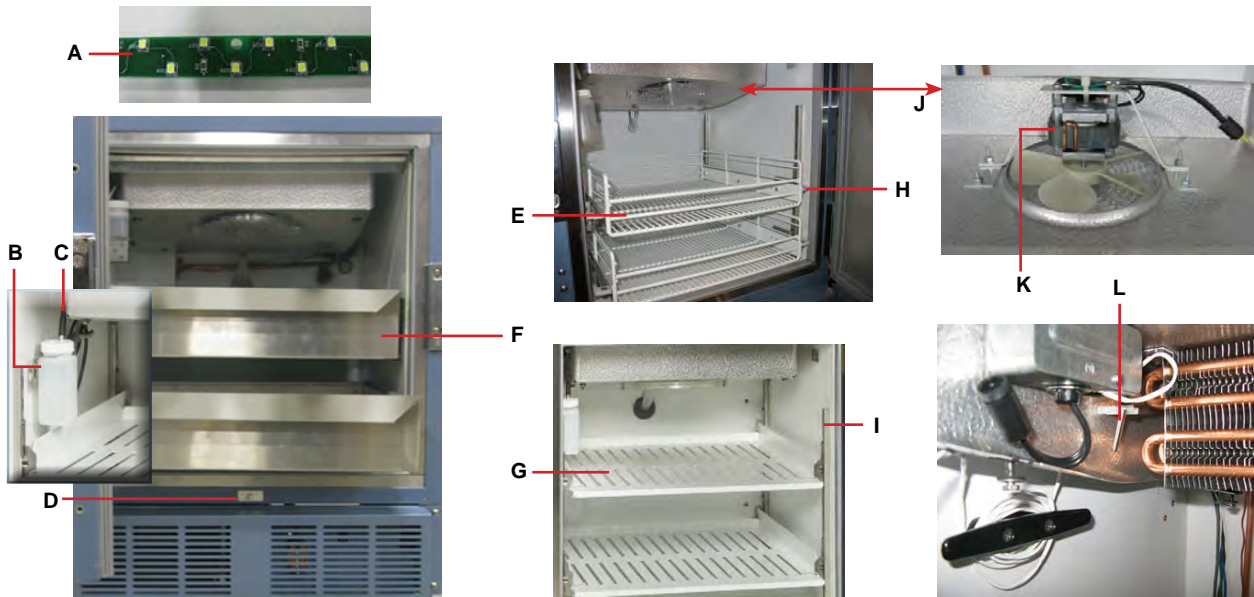

Letter	Description	Part Number	Model	Letter	Description	Part Number	Volts
A	Light assembly (circuit board and cover)	800023-1	-	G	Full shelf (Lab/Pharmacy) * = Serial # 2041434 and prior	400914-1	-
B	Primary monitor probe	800029-1	-			400814-1*	-
C	Probe bottle and glycerin kit	400922-1	-	H	Slide assembly (drawer, basket)	400753-2	-
Not Shown	Chart recorder probe	800024-1	-	I	Standard (shelf, drawer, basket)	321173-1	-
D	Door switch	120380	-	J	Unit cooler assembly	800130-1	120
E	Roll out basket assembly (optional)	400815-1	105			800824-1	230
		401133-1	104	K	Unit cooler fan motor	800836-1	115
F	Drawer assembly (Blood Bank)	400752-3	105			800835-1	230
		401123-1	104	L	Control probe	800028-1	-

Horizon Series Information

**⚠ CAUTION**

- Disconnect unit from AC power before opening the electrical box.

**Note**

Circuit boards are sensitive to static electricity and can be damaged by electrostatic discharge. Use proper ESD precautions when handling the board.

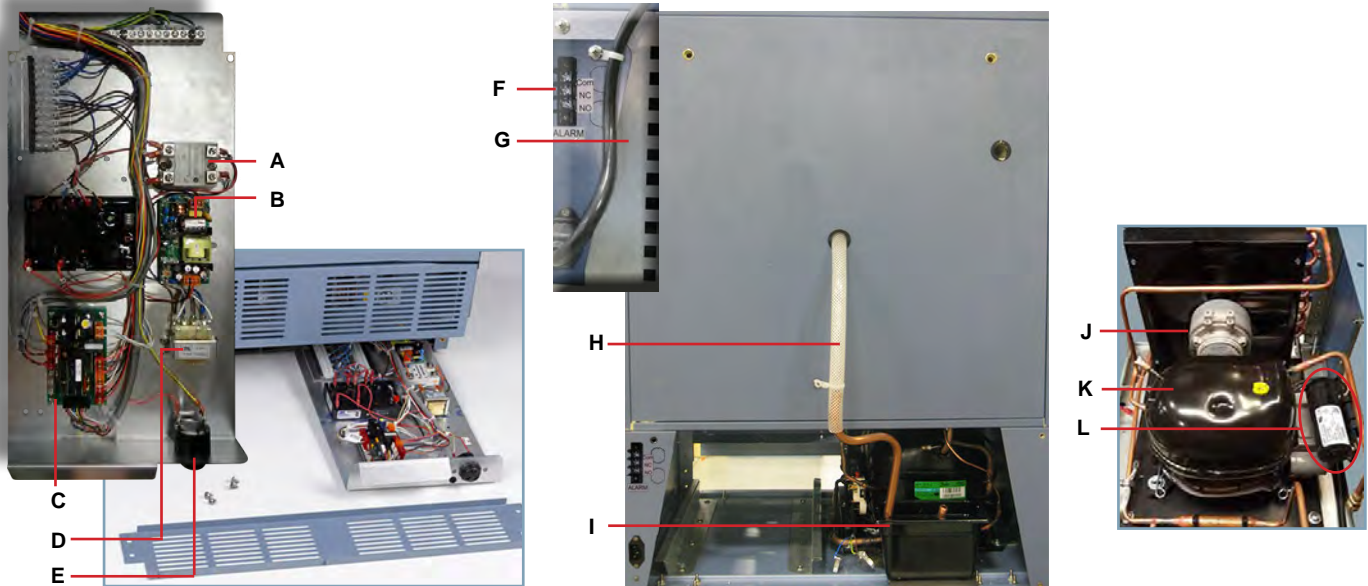

Letter	Description	Part Number	Volts	Letter	Description	Part Number	Volts
A	Solid state relay	800920-1	-	J	Condenser fan motor assembly (Embraco)	800905-1	115
B	Back-up battery (optional Access Control)	800035-1	-			8009071	230
C	Control board	800277-1	-		Condenser fan motor assembly (Danfoss)	120787	115
D	Temperature control transformer	401097-1	115			120609	230
		401098-1	230				
E	Alarm buzzer	120160	-	K	Compressor (Embraco)	800912-1	115
Not Shown	Power line filter	120299	-			800913-1	230
						F	Remote alarm contacts
G	Rear cover	321184-1	-	L	Compressor start relay/start capacitor/OLP kit (Embraco)		
H	Drain hose	321190-1	-			800906-1	230
I	Condensate evaporator tray	-	-	Not Shown		800142-1	115
						120605	230
						120607	230

Horizon Series Information



## 15 Schematics

### 15.1 HB and HLR Models; 104 and 105 Configuration (without Access Control)

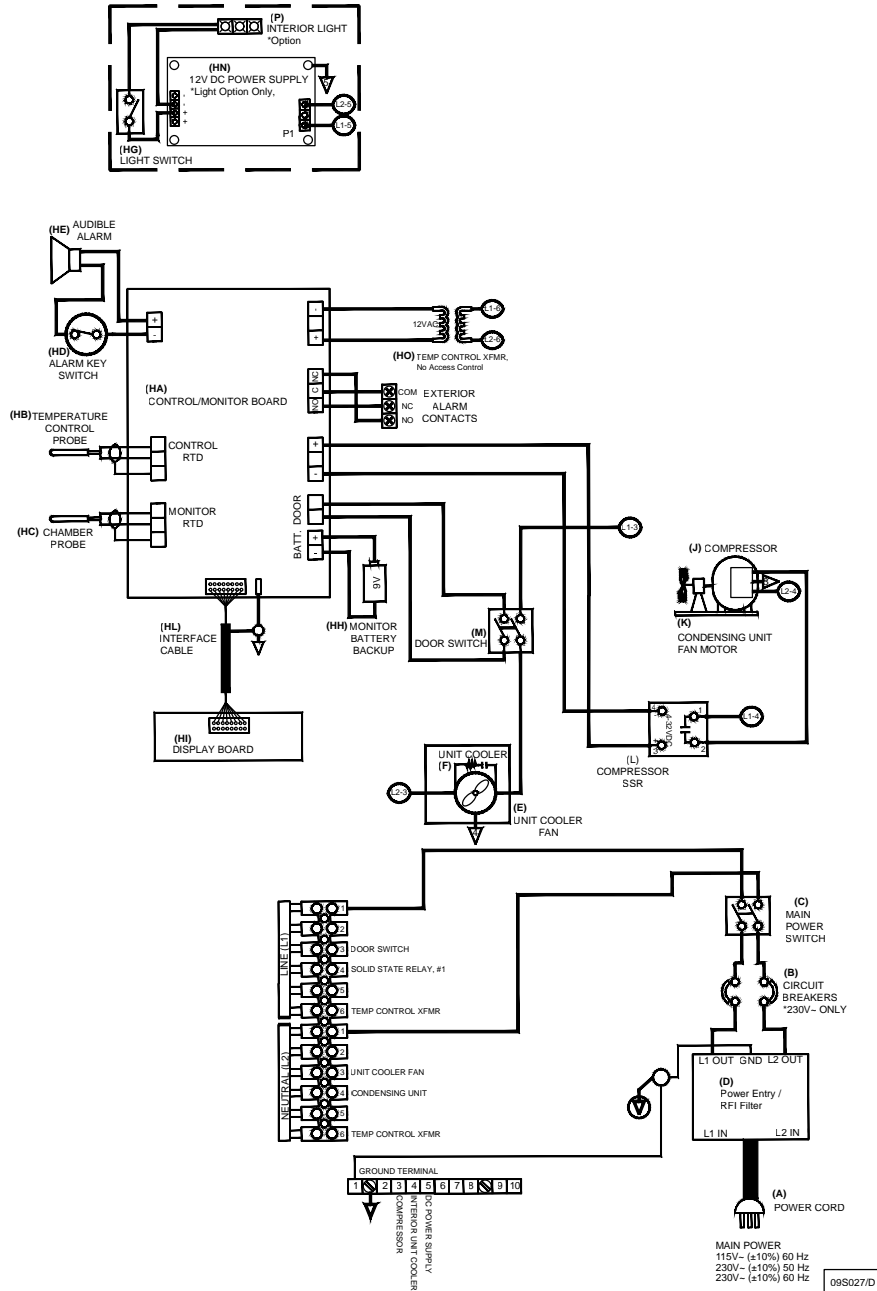

THESE DRAWINGS AND SPECIFICATIONS ARE THE SOLE PROPERTY OF HELMER INC. AND SHALL NOT BE REPRODUCED OR USED AS THE BASIS FOR MANUFACTURE OR SALES OF APPARATUS WITHOUT THE APPROVAL OF HELMER INC.

Horizon Series Information

15.2 HB and HLR Models; 104 and 105 Configuration (with Access Control)

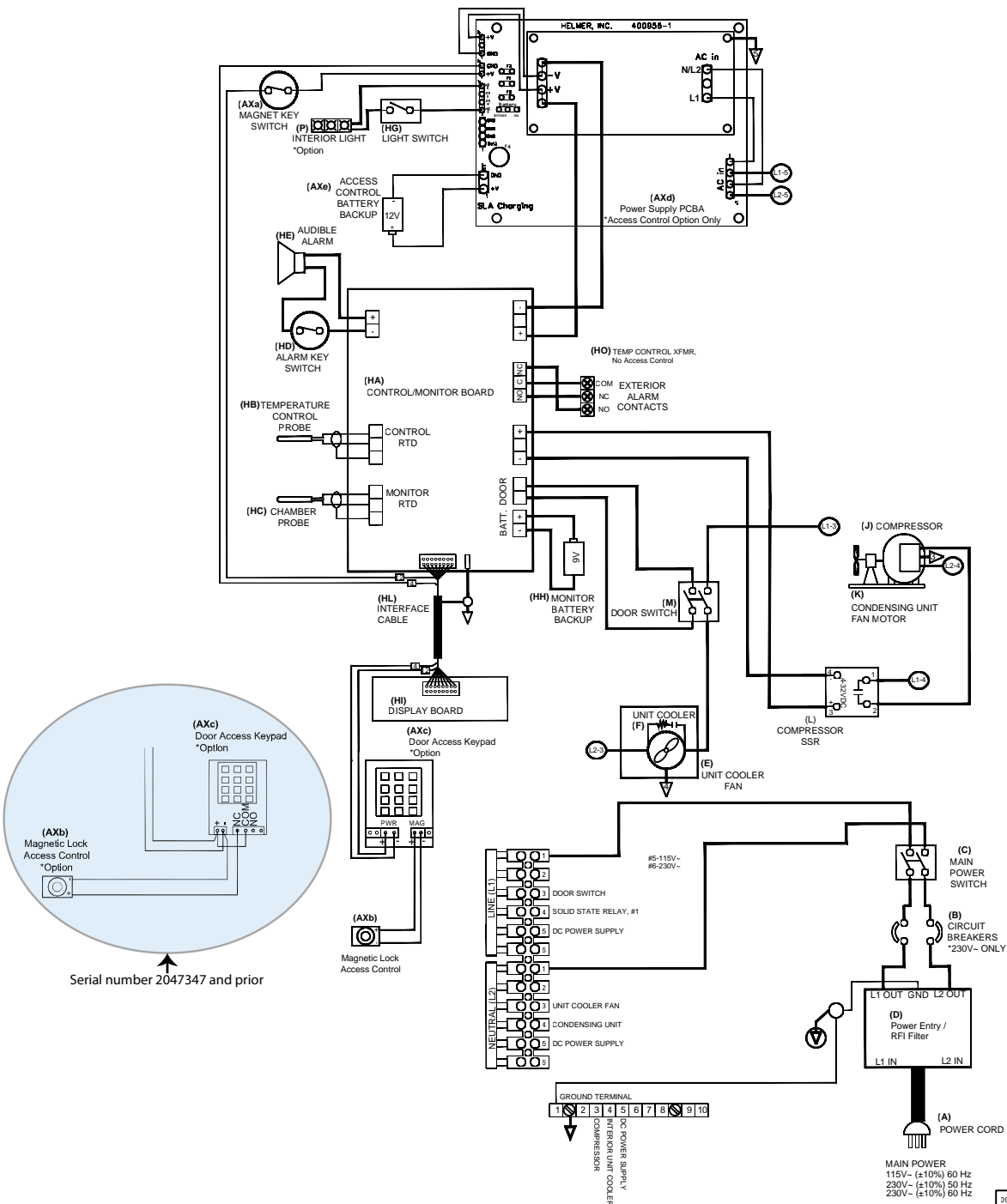

THESE DRAWINGS AND SPECIFICATIONS ARE THE SOLE PROPERTY OF HELMER INC. AND SHALL NOT BE REPRODUCED OR USED AS THE BASIS FOR MANUFACTURE OR SALES OF APPARATUS WITHOUT THE APPROVAL OF HELMER INC.

Horizon Series Information

### 15.3 Defrost Timer for HB and HLR, Models; 104 and 105 Configuration

**Note**

The Defrost Timer applies to only to HB and HLR models with serial numbers prior to 2047345.

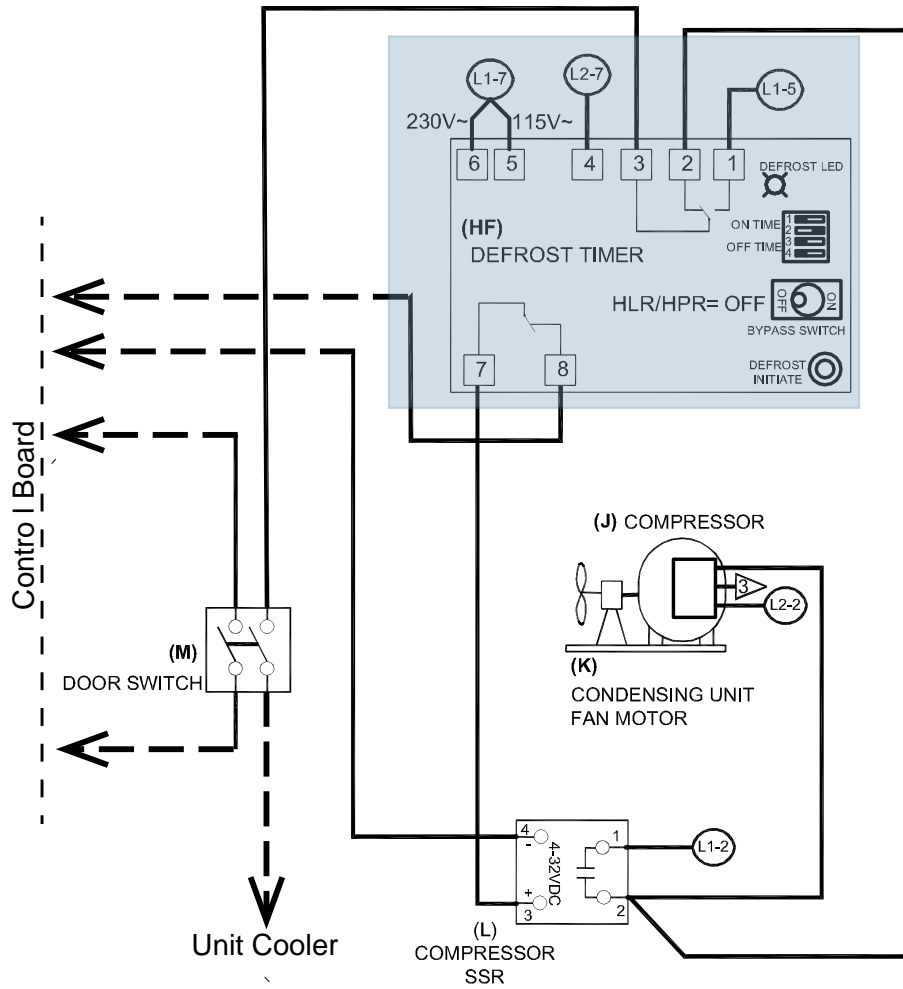

THESE DRAWINGS AND SPECIFICATIONS ARE THE SOLE PROPERTY OF HELMER INC. AND SHALL NOT BE REPRODUCED OR USED AS THE BASIS FOR MANUFACTURE OR SALES OF APPARATUS WITHOUT THE APPROVAL OF HELMER INC.

## Appendix A: Compliance

### Regulatory Compliance

This device complies with the requirements of directive 93/42/EEC concerning Medical Devices, as amended by 2007/47/EC.

This device complies with FCC Radiated and Conducted Emissions Approval to CFR47, Part 15; Class A levels.

Sound level is less than 70 dB(A).



<b>EC</b>	<b>REP</b>	Emergo Europe Prinsessegracht 20 2514 AP The Hague The Netherlands
-----------	------------	---

### WEEE Compliance

The WEEE symbol (right) indicates this product falls under the scope of the WEEE (Waste Electrical and Electronic Equipment) directive.

When disposing of this product in countries affected by this directive:

- ◆ Do not dispose of this product as unsorted municipal waste.
- ◆ Collect this product separately.
- ◆ Use collection and return systems available locally.

For more information on the return, recovery, or recycling of this product, contact your local distributor.

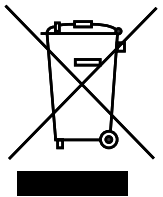

## Appendix B: Warranty

### Rel.i™ Product Warranty USA and Canada

For technical service needs, please contact Helmer at 800-743-5637 or [www.helmerinc.com](http://www.helmerinc.com). Have the model and serial number available when calling.

#### Rapid Resolution

When a warranty issue arises it is our desire to respond quickly and appropriately. The service department at Helmer is there for you. Helmer will oversee the handling of your warranty service from start to finish. Therefore, Helmer must give advance authorization for all service calls and/or parts needs relating to a warranty issue. Any repeat service calls must also be authorized as well. This allows for proper diagnosis and action. Helmer will not be responsible for charges incurred for service calls made by third parties prior to authorization from Helmer. Helmer retains the right to replace any product in lieu of servicing it in the field.

#### Compressor

For the warranty period listed below, Helmer will supply the refrigeration compressor, if it is determined to be defective, at no charge, including freight. Helmer will not be liable for installation, refrigerant, or miscellaneous charges required to install the compressor beyond the first year of the warranty period.

- ◆ i.Series model compressor warranty period is seven (7) years.
- ◆ Horizon Series model compressor warranty period is five (5) years.

#### Parts

For a period of two (2) years, Helmer will supply at no charge, including freight, any part that fails due to defects in material or workmanship under normal use, with the exception of expendable items. Expendable items such as glass, filters, light bulbs, and door gaskets are excluded from this warranty coverage. Inspection of defective parts by Helmer will be final in determining warranty status. Warranty procedures must be followed in all events.

#### Labor

For a period of one (1) year, Helmer will cover repair labor costs (including travel) and the cost of refrigerant and supplies necessary to perform authorized repairs. Repair service must be performed by an authorized Helmer service agency following the authorization process detailed above. Alternatively, your facility's staff may work with a Helmer technician to make repairs. Labor costs for repairs made by unauthorized service personnel, or without the assistance of a Helmer technician, will be the responsibility of the end user.

#### Additional Warranty Information

The time periods set forth above begin two (2) weeks after the original date of shipment from Helmer. Warranty procedures set forth above must be followed in all events.

THERE ARE NO WARRANTIES WHICH EXTEND BEYOND THE DESCRIPTION ON THE FACE HEREOF. THIS WARRANTY IS EXCLUSIVE AND IN LIEU OF ALL OTHER WARRANTIES, EXPRESS OR IMPLIED, INCLUDING WITHOUT LIMITATION ANY WARRANTY OF MERCHANTABILITY OR FITNESS FOR A PARTICULAR PURPOSE. NO WARRANTIES OF MERCHANTABILITY OR FITNESS FOR PARTICULAR PURPOSE SHALL APPLY.

THE LIABILITY, IF ANY, OF HELMER FOR DIRECT DAMAGES WHETHER ARISING FROM A BREACH OF ANY SALES AGREEMENT, BREACH OF WARRANTY, NEGLIGENCE, OR INDEMNITY, STRICT LIABILITY OR OTHER TORT, OR OTHERWISE WITH RESPECT TO THE GOODS OR ANY SERVICES IS LIMITED TO AN AMOUNT NOT TO EXCEED THE PRICE OF THE PARTICULAR GOODS OR SERVICES GIVING RISE TO THE LIABILITY. IN NO EVENT SHALL HELMER BE LIABLE FOR ANY INDIRECT, INCIDENTAL, CONSEQUENTIAL, OR SPECIAL DAMAGES, INCLUDING WITHOUT LIMITATION DAMAGES RELATED TO LOST REVENUES OR PROFITS, OR LOSS OF PRODUCTS.

This warranty does not cover damages caused in transit, during installation by accident, misuse, fire, flood, or acts of God. Further, this warranty will not be valid if Helmer determines that the failure was caused by a lack of performing recommended equipment maintenance (per Helmer manual) or by using the product in a manner other than for its intended use. Installation and calibration are not covered under this warranty agreement.

#### Outside of USA and Canada

Consult your local distributor for warranty information.

END OF MANUAL

## Helmer Scientific

14400 Bergen Boulevard, Noblesville, IN 46060 USA