

Refrigerator Operation Manual

i.Series® and Horizon Series™ - Pass- Thru

Blood Bank

i.Series

iB225 (Version D)

iB456 (Version D)

Horizon Series

HB225 (Version D)

HB456 (Version D)

Pharmacy

i.Series

iPR225 (Version D)

iPR456 (Version D)

Horizon Series

HPR225 (Version D)

HPR456 (Version D)



Document History

Revision	Date	CO	Supersession	Revision Description
A	23 JAN 2013	6666	n/a	Initial release (as version D, revision A).
B	14 JUL 2014*	9665	B supersedes A	Added 230 V information and CE certification.
C	16 MAR 2015	10321	C supersedes B	<ul style="list-style-type: none">Updated instruction in Section III, Items 9.2 through 9.7.1 to reflect use of monitor and control interface with new Min/Max temperature recording feature.Added Document Updates, to Document History page.Added Confidential / Proprietary Notice, Section I, Item 1.4 and Disclaimer, Section I, Item 1.5.Moved Maintenance Schedule, i.Series® Components and Horizon Series™ Components to Appendices A, B and C.
D	2 MAY 2016	11831	D supersedes C	<ul style="list-style-type: none">Reformatted content.Added product loading guidelines in response to CAPA 10843.Added quarterly inspection of ground strap to Preventive Maintenance table in response to CAPA 10792.

* Date submitted for Change Order review. Actual release date may vary.

Document Updates

The document is furnished for information use only, is subject to change without notice and should not be construed as a commitment by Helmer Scientific. Helmer Scientific assumes no responsibility or liability for any errors or inaccuracies that may appear in the informational content contained in this material. For the purpose of clarity, Helmer Scientific considers only the most recent revision of this document to be valid.

Notices and Disclaimers

Confidential / Proprietary Notices

Use of any portion(s) of this document to copy, translate, disassemble or decompile, or create or attempt to create by reverse engineering or otherwise the information from Helmer Scientific products is expressly prohibited.

Copyright and Trademark

Copyright © 2016 Helmer, Inc. Helmer®, i.Series®, i.C³®, Horizon Series™, and Rel.i™ are registered trademarks or trademarks of Helmer, Inc. in the United States of America. All other trademarks and registered trademarks are the property of their respective owners. Helmer, Inc., doing business as (DBA) Helmer Scientific and Helmer.

Disclaimer

This manual is intended as a guide to provide the operator with necessary instructions on the proper use and maintenance of certain Helmer Scientific products.

Any failure to follow the instructions as described could result in impaired product function, injury to the operator or others, or void applicable product warranties. Helmer Scientific accepts no responsibility for liability resulting from improper use or maintenance of its products.

The screenshots and component images appearing in this guide are provided for illustrative purposes only, and may vary slightly from the actual software screens and/or product components.

Contents

1	About this Manual	4
1.1	Safety Precautions and Symbols	4
1.2	General Recommendations	5
2	Installation	6
2.1	Location	6
2.2	Placement and Leveling	6
2.3	Chart Recorder (If Included)	8
3	i.Series® Operation	10
3.1	Initial Power-Up	10
3.2	Operation	11
3.3	Change Temperature Setpoint	11
3.4	Set Alarm Parameters	12
3.5	Active Alarms	12
3.6	Mute and Disable Active Alarms	13
3.7	Light Operation	13
4	Horizon Series™ Operation	14
4.1	Initial Power Up	14
4.2	Display Minimum and Maximum Monitor Temperature Recordings	14
4.3	Change Temperature Setpoint	15
4.4	Set Parameter Values	16
4.5	Set Temperature Units	16
4.6	Temperature Calibration Offsets	16
4.7	Set Alarm Setpoints (Parameters)	17
4.8	Active Alarms	17
4.9	Mute and Disable Audible Alarms	17
4.10	Light Operation	17
5	Product Specifications	18
5.1	Operating Standards	18
6	Compliance	20
6.1	Regulatory Compliance	20
6.2	WEEE Compliance	20
7	Preventive Maintenance	21
	Appendix A	22
	i.Series Parts	22
	Appendix B	23
	Horizon Series Parts	23

1 About this Manual

This manual provides information on how to use i.Series® and Horizon Series™ blood bank and pharmacy refrigerators. It is intended for use by end users of the refrigerator and authorized service technicians.

Models are indicated by a distinguishing model number that corresponds to the series, type, number of doors and capacity of the freezer. For example, “iPR225” refers to an i.Series Pharmacy Refrigerator with 2 doors and a capacity of 25 cu ft.

Generic references are used throughout this manual to group models that contain similar features. For example, “225 models” refers to all models of that size (iB225, HB225, iPR225, HPR225). This manual covers all pass-thru refrigerators, which may be identified singly, by their size, or by their respective “Series.”

1.1 Safety Precautions and Symbols

Symbols found in this document

The following symbols are used in this manual to emphasize certain details for the user:



Task Indicates procedures which need to be followed.



Note Provides useful information regarding a procedure or operating technique when using Helmer Scientific products.



NOTICE Advises the user against initiating an action or creating a situation which could result in damage to equipment; person injury is unlikely.



CAUTION Advises the user against initiating an action or creating a situation which could result in damage to equipment or impair the quality of the products or cause minor injury.



WARNING Advises the user against initiating an action or creating a situation which could result in damage to equipment and serious personal injury to a patient or the user.



Manufacturer



Authorized representative in the European Community

Symbols found on the units

The following symbols may be found on the refrigerator or refrigerator packaging:



CE Mark (European units only)



Earth / ground terminal



Caution: Risk of damage to equipment or danger to operator



Protective earth / ground terminal



Caution: Hot surface



Compliance with Restriction of Hazardous Substances Directive



Caution: Shock / electrical hazard



Compliance with European Union Directive WEEE 2002/96/EC applicable provisions.



Caution: Unlock all casters

Avoiding Injury

Review safety instructions before installing, using, or maintaining the equipment.

- ◆ Before moving unit, ensure doors are closed and casters are unlocked and free of debris.
- ◆ Before moving unit, disconnect the AC power cord and secure the cord.
- ◆ Do not open multiple, loaded drawers at the same time.
- ◆ Do not move a unit whose load exceeds 900 lbs / 408 kg (single-door units) or 1350 lbs / 612 kg (double-door units).
- ◆ Never physically restrict any moving component.
- ◆ Avoid removing electrical service panels and access panels unless so instructed.
- ◆ Keep hands away from pinch points when closing the door.
- ◆ Avoid sharp edges when working inside the electrical compartment and refrigeration compartment.
- ◆ Ensure biological materials are stored at recommended temperatures determined by standards, literature, or good laboratory practices.
- ◆ Proceed with caution when adding and removing samples from the refrigerator.
- ◆ Use manufacturer supplied power cord only.
- ◆ Using the equipment in a manner not specified by Helmer Scientific may impair the protection provided by the equipment.
- ◆ Decontaminate parts prior to sending for service or repair. Contact Helmer Scientific or your distributor for decontamination instructions and a Return Authorization Number.
- ◆ Ensure biological materials are stored safely, in accordance with all applicable organizational, regulatory, and legal requirements.
- ◆ The refrigerator is not considered to be a storage cabinet for flammable or hazardous materials.

CAUTION

Decontaminate parts prior to sending for service or repair. Contact Helmer or your distributor for decontamination instructions and a Return Authorization Number.

1.2 General Recommendations

Intended Use

Helmer refrigerators are intended for the storage of blood products and other medical and scientific products.

General Use

Allow refrigerator to come to room temperature before powering on.

During initial startup, high temperature alarm may activate while refrigerator reaches operating temperature.

CAUTION

Do not remove the cover from the condensate evaporator tray

Initial Loading

Allow chamber temperature to stabilize at the setpoint before storing product.

Product Loading Guidelines

When loading your refrigerator, take care to observe the following guidelines:

- ◆ Never load refrigerators beyond capacity.
- ◆ Always store items within shelves, drawers or baskets.
- ◆ Temperature uniformity is maintained by air circulation, which could be impeded if unit is overfilled, particularly at the top or against the doors or walls. Ensure proper clearance is provided below the fan.

Note

Products stacked against walls or doors may obstruct air flow and affect performance of unit.

2 Installation

2.1 Location

- ◆ Has a grounded outlet meeting the electrical requirements listed on the product specification label.
- ◆ Is clear of direct sunlight, high temperature sources, and heating and air conditioning vents.
- ◆ Minimum 8" (203 mm) above.
- ◆ Meets limits specified for ambient temperature (15°C to 32°C) and relative humidity.
- ◆ Clearance above the clean room side may be 0".
- ◆ Top enclosure cannot be placed more than 11" (280 mm) from the front (clean room side) of the refrigerator.
- ◆ Side enclosures may be flush with both sides of the refrigerator.

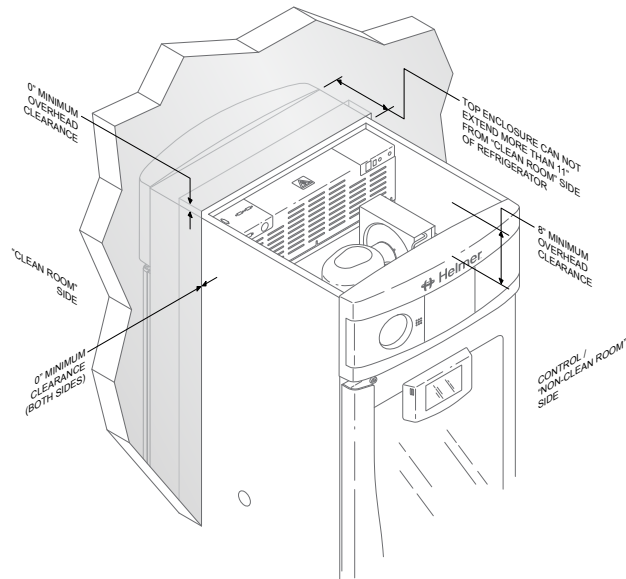

Clearance requirements for pass-thru refrigerator enclosure.

2.2 Placement and Leveling

CAUTIONS

- To prevent tipping, ensure the casters are unlocked, and the doors are closed before moving the refrigerator.
1. Roll refrigerator into place and lock casters.
 2. Ensure refrigerator is level.

Primary Monitor Probe

The primary monitor probe is located in the top right corner of the refrigerator (as accessed from the clean room side).



Primary monitor probe with optional chart recorder probe

Secondary Probe

The secondary probe is located in the lower right corner of the refrigerator.



Secondary probe

Fill Temperature Probe Bottle

i Note

For each probe bottle, use approximately 4 oz. (120 mL) of product simulation solution (10:1 ratio of water to glycerin) (Packet included in refrigerator box)

1. Remove all probes from bottle and remove bottle from bracket.
2. Remove cap and fill with approximately 4 oz. (120 mL) of product simulation solution.
3. Secure cap on bottle and place in bracket.
4. Replace probes, immersing at least 2" (50 mm) in solution.

Install Additional Probe Through Top Port



Top access port

1. Peel back putty to expose port.
2. Insert probe through port into chamber.
3. Insert probe into bottle.
4. Replace putty, ensuring a tight seal.

2.3 Chart Recorder (If Included)

Note

For complete information, refer to the Temperature Chart Recorder Operation and Service Manual provided with this unit.



The chart recorder has a back-up battery system enabling a period of continuous operation if power is lost. Battery life varies by manufacturer as well as voltage level remaining. If full battery power is available, back-up power for the temperature chart recorder is available for up to 14 hours.

Note

If chart recorder is operated on battery power, the battery should be replaced to ensure the back-up source has proper charge.

Prior to use:

Place probe in bottle with primary monitor probe.

Set up and Operation

Access chart recorder by pressing and releasing (i.Series) or pulling door open (Horizon Series).



i.Series chart door



Horizon Series chart door

Install battery.

Connect the leads to the battery to provide back-up power to the chart recorder.

Install / Replace Chart Paper

Note

For accurate temperature reading, ensure the current time is aligned with the time line groove when the chart knob is fully tightened.

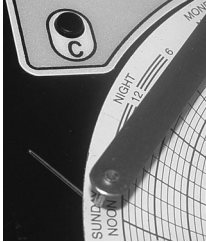

Chart recorder stylus and time line groove

1. Press and hold C button. When stylus begins to move left, release button. The LED flashes.
2. When stylus stops moving, remove chart knob then move knob up and away.
3. Place chart paper on chart recorder.
4. Gently lift stylus and rotate paper so current time line corresponds to time line groove.
5. Hold chart paper in place while making sure the chart knob is fully tightened. *(Failure to fully tighten the knob can result in paper slipping and losing time.)*
6. Press and hold C button. When stylus begins to move right, release button.
7. Confirm stylus is marking on paper and stops at the correct temperature.
8. Calibrate chart recorder to match primary temperature if needed and close recorder door.

Power Supply

The temperature chart recorder uses AC power when the system is operating. If AC power fails, the recorder continues to record temperature with back-up power provided by the nine-volt battery.

- ◆ The LED indicator glows green continually when main power is functioning and the battery is charged.
- ◆ The LED indicator glows red continually when main power is functioning and the battery is either not installed or needs to be changed.
- ◆ The LED indicator flashes red to indicate that the recorder is receiving power only from the back-up battery.
- ◆ The LED indicator flashes during chart paper change mode.

3 i.Series® Operation

3.1 Initial Power-Up

1. Plug the power cord into a grounded outlet that meets the electrical requirements on the product specification label.
2. Turn the AC power switch ON.
3. Turn the Back Up battery switch ON.

Note

The Start screen is displayed when the i.C³ is powered on. The i.C³ will take approximately 2-5 minutes to boot up.



Start screen

On the Language screen, touch the Language button, then select the preferred language from the drop-down menu. If English is the preferred language, touch the Home button.

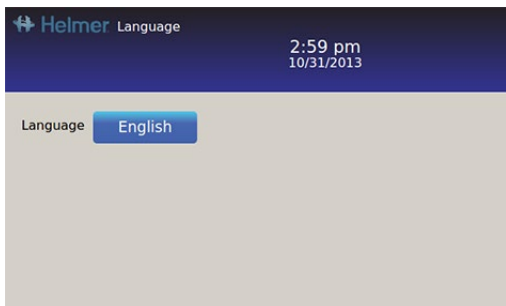

Language screen

If an alarm sounds, temporarily mute the alarm by touching the Mute button.



Home screen - alarm muted



Mute icon

Note

Active alarms are displayed on the Home screen. If an alarm condition other than High Temperature occurs, refer to the service manual for troubleshooting.

3.2 Operation

Notes

- Refer to the i.C³ User Guide for complete information regarding the i.C³ User Interface.
- The i.C³ Home screen displays temperature and alarm information, and provides icons to gain access to other functions of the i.C³.
- After two minutes of inactivity, the screensaver will be displayed. To return to the Home screen, touch the screensaver.



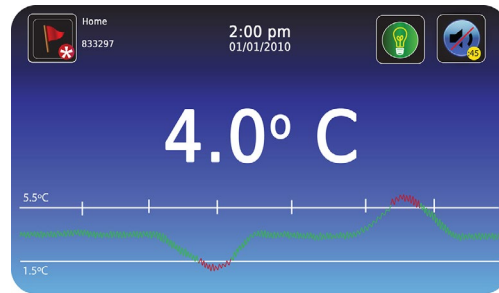

Home screen.



Home screensaver (touch to return to Home screen).

3.3 Change Temperature Setpoint

 >  > Enter the Settings password. Scroll down to select Temperature Setpoints. Touch + or – on spin box to change value.

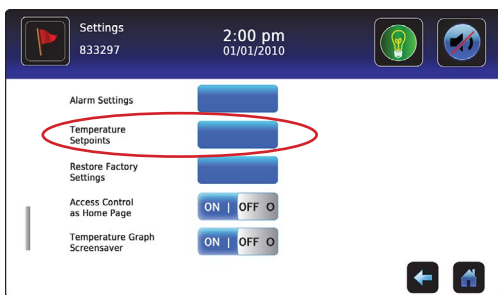

Settings screen

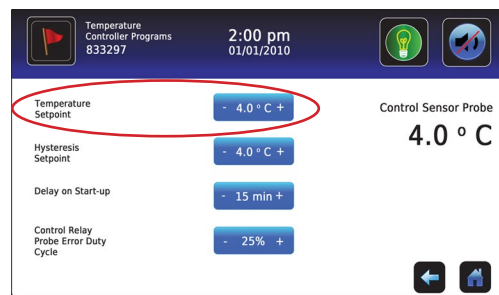



Temperature Controller Programs screen

Notes

- Default Settings password is 1234.
- Default setpoint is 4.0 °C.

3.4 Set Alarm Parameters

 >  > Enter the Settings password. Scroll down to select Alarm Settings. Touch + or – on spin box to set each alarm parameter.

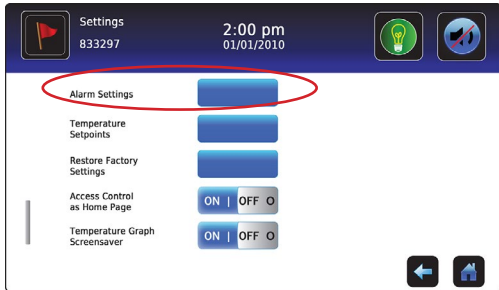

Settings screen



Alarms screen

Alarm settings control the conditions and timing of alarm condition indicators displayed on the i.C³ Home screen.

3.5 Active Alarms



Home screen with active alarm

Table 1. i.Series Active Alarms

Alarm	Description
High Temperature	Chamber temperature reading is above high temperature alarm setpoint
Low Temperature	Chamber temperature reading is below low temperature alarm setpoint
Low Battery	Rechargeable battery voltage is low
No Battery	Battery is not connected
Power Failure	Power to unit has been disrupted
Probe Failure	Probe not functioning properly
Door Open	Door is open beyond user-specified duration
Compressor Temperature	Compressor temperature reading is above high temperature alarm setpoint
Communication Failure Messages 1, 2, 3	1 Communication lost between i.C³ display board and control board 2 Communication lost between i.C³ display board and internal system memory 3 Corrupt database

3.6 Mute and Disable Active Alarms

Audible alarms may be muted by touching the Mute icon to set delay.



Unmuted



Muted



















3.7 Light Operation

Press Light Icon to turn LED lights ON or OFF.
Auto ON/OFF feature can be configured in Settings.



Light ON/OFF

Table 2. i.C³ Icon Reference Guide

Alarm	Description	Alarm	Description	Alarm	Description
	Home		Mute		Compressor Log
	Event Log		Download		Icon Transfer
	Settings		Upload		Display Brightness
	i.C ³ Applications		Light On/Off		Scroll Arrows
	Back Arrow		Temperature Graph		Contact Helmer
	Alarm Conditions		Information Log		Battery Power
	Alarm Test				

4 Horizon Series™ Operation

4.1 Initial Power Up

1. Plug the power cord into a grounded outlet that meets the electrical requirements on the product specification label.
2. Turn the AC power switch ON.
3. Install 9 V back-up battery located on top of unit.
4. Press **Down Arrow** (Mute) if high temperature alarm sounds.



Note

If an alarm condition other than High Temperature occurs, refer to the service manual for troubleshooting.

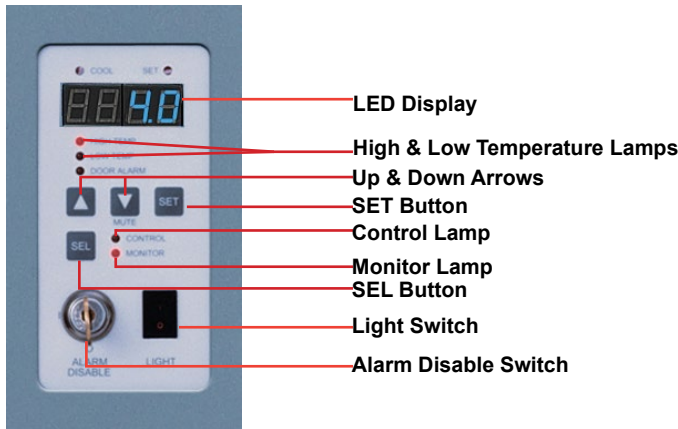

Monitor and Control Panel

4.2 Display Minimum and Maximum Monitor Temperature Recordings

Notes

- This feature is standard on Horizon Series™ models with serial numbers of 2015494 or higher. Some exceptions may exist. For confirmation on your unit, please contact Helmer Technical Service.
- This feature only applies to the Monitor temperature probe.
- Units which do not include the minimum and maximum recording feature will not display °C or °F when entering the program mode.

The minimum and maximum recording feature allows the user to view a minimum temperature occurrence and a maximum temperature occurrence within a given period of time. The timer provides a time reference in which those temperatures occurred.

View minimum temperature recording

1. Press and hold the **Down Arrow** button for 1 second and listen for a single beep.
2. The display will alternate between **LO** and a valid temperature value five (5) times followed by a single beep to indicate exit back to the temperature display.



View maximum temperature recording



1. Press and hold the **Up Arrow** button for 1 second and listen for a single beep.
2. The display will alternate between **HI** and a valid temperature value five (5) times followed by a single beep to indicate exit back to the temperature display.





View recorded temperature timer

Notes

- The timer denotes the period of time that has elapsed. It does not display the time at which a minimum or maximum temperature occurred.
- The maximum period of time the timer can record is 99:59 (99 hours and 59 minutes).

1. Press and hold either the **Up** or **Down Arrow** button for 1 second.  or 
2. While the display is flashing the **HI** or **LO** value, press and hold the **SET** button for 1 second.
3. The display will alternate five (5) times between **CLr** and a value representing the number of hours and minutes that have elapsed since the last recording (example: 12:47 would represent 12 hours and 47 minutes). A single beep will follow to indicate exit back to temperature display.

Clear minimum and maximum temperature recordings

1. Press and hold either the **Up** or **Down Arrow** button for 1 second.  or 
2. While the display is flashing the **HI** or **LO** value, press and hold the **SET** button for 1 second and listen for a single beep.
3. While the display is flashing the elapsed time since last reset, press and hold the **SET** button for 2 seconds. **CLr** will be displayed followed by a series of 3 beeps to indicate exit back to the temperature display.

Notes

The minimum and maximum temperature and timer will reset when:

- the unit is powered off and battery back-up is not engaged, or
- after 99 hours and 59 minutes have elapsed.

4.3 Change Temperature Setpoint

Note

Default setpoint is 4.0°C

1. Press and release **SEL** to change to Control mode. The CONTROL lamp will illuminate.
2. Press and hold **SET** to display the current setpoint temperature.
3. Hold **SET** and press the **Up** or **Down Arrow** as necessary to set the desired setpoint value.
4. Release all buttons; the setpoint is changed.
5. Press and release **SEL** to return to Monitor mode. The MONITOR lamp will illuminate.

4.4 Set Parameter Values

1. Press and hold the **Up** and **Down Arrows** simultaneously for 3 seconds to enter program mode.
2. The LED Display will show .C or .F to indicate Celsius or Fahrenheit.
3. Press and release **SEL** button to scroll through the parameters.
4. Once the desired parameter is selected, press and hold the **SET** button while pressing the **Up** or **Down Arrow** to select the desired value.
5. Release **SET** button. The new setting is saved.
6. Press and hold the **Up** and **Down Arrows** simultaneously for 3 seconds to exit program mode.

Note

Contact Helmer Technical Service to set Hysteresis values.

Table 3. Parameter Values

Parameter	Visual Indicator	Range	Default
Celsius or Fahrenheit	None	°C, °F	°C
High Temperature	MONITOR Lamp & HIGH Lamp	-40.0 to 25.0 (°C); -40 to 77 (°F)	5.5 °C
Low Temperature	MONITOR Lamp & LOW Lamp	-40.0 to 25.0 (°C); -40 to 77 (°F)	1.5 °C (HB); 2.0 °C (HPR)
Monitor Offset	MONITOR Lamp	-10.0 to 10.0 (°C); -18 to 18 (°F)	Varies
Control Offset	CONTROL Lamp	-10.0 to 10.0 (°C); -18 to 18 (°F)	Varies
Hysteresis	CONTROL Lamp	0.5 to 2.5 (°C); 1 to 5 (°F)	1.5°C

4.5 Set Temperature Units

Note

If temperature units are changed, the temperature setpoints, offsets and alarm settings must be recalibrated.

1. Press and hold the **Up** and **Down Arrows** simultaneously for 3 seconds to enter program mode.
2. The LED Display will show °C or °F to indicate Celsius or Fahrenheit.
3. Press and hold the **SET** button while pressing the **Up** or **Down Arrow** to select the desired temperature unit.
4. Release **SET** button. The new setting is saved.
5. Press and hold the **Up** and **Down Arrows** simultaneously for 3 seconds to exit program mode.

4.6 Temperature Calibration Offsets

Temperature calibration offsets indicate an acceptable margin of error between the actual temperature value and the desired temperature value.

Monitor Offset

- ◆ Adjust if temperature displayed on the monitor is outside a range of $\pm 0.3^{\circ}\text{C}$ when compared to a calibrated reference thermometer in the same probe bottle.
- ◆ Value is factory-set to match a calibrated reference thermometer.
- ◆ Refer to the service manual for instructions regarding changing the Monitor Offset.

Control Sensor Offset and Hysteresis

The control sensor affects the reading of the control probe temperature and therefore the actual temperature of the refrigerator. This should not be adjusted from the original setting unless directed by Helmer Technical Service.

Hysteresis helps control the refrigeration based on the control probe temperature reading and the set point and should not be changed from the default setting.

NOTICE

Control Sensor Offset and Hysteresis are factory-preset and should not be changed. Contact Helmer Technical Service for instructions regarding changing these values.

4.7 Set Alarm Setpoints (Parameters)

1. Press and hold the **Up** and **Down Arrows** simultaneously for 3 seconds to enter program mode.
2. The LED Display will show °C or °F to indicate Celsius or Fahrenheit.
3. Press **SEL** until HIGH TEMP or LOW TEMP and MONITOR lamps flash.
4. Hold **SET**, then press **Up** or **Down Arrow** to change the setpoint.
5. Release **SET** button. The new setting is saved.
6. Press and hold **Up** and **Down Arrows** simultaneously for 3 seconds to exit program mode.

4.8 Active Alarms

The controller displays temperature and alarm information.

Table 4. Horizon Series Active Alarms

Alarm	Visual Indicator	Description
High Temperature	HIGH TEMP lamp flashes	Chamber temperature reading is above high temperature alarm setpoint
Low Temperature	LOW TEMP lamp flashes	Chamber temperature reading is below low temperature alarm setpoint
Power Failure	"PoFF" appears on display	Power to unit has been disrupted
Probe Failure	"Prob" appears on display	Probe not functioning properly
Door Open < 3 min.	DOOR ALARM lamp lights	Door is open (less than three minutes)
Door Open > 3 min.	DOOR ALARM lamp flashes	Door has been open 3 minutes or longer*

*Audible alarm will sound after door is open for 3 minutes.

4.9 Mute and Disable Audible Alarms

Note

Muting audible alarms does not disable alarm lamps or signals sent through the remote alarm interface.

- ◆ Press **Down Arrow** (Mute) to mute audible alarms.
- ◆ To disable all audible alarms, insert the key in the Alarm Disable switch and turn.

4.10 Light Operation

The light switch is located on the monitoring and control panel and controls the LED light within the chamber.

5 Product Specifications

5.1 Operating Standards

These units are designed to operate under the following environmental conditions:

- ◆ Indoor use only
- ◆ Altitude (maximum): 2000 m
- ◆ Ambient temperature range: 15 °C to 32 °C
- ◆ Relative humidity (maximum for ambient temperature): 80% for temperatures up to 31 °C, decreasing linearly to 50% at 40 °C
- ◆ Overvoltage category: II
- ◆ Pollution degree: 2

Table 5. Electrical Specifications (Blood Bank and Pharmacy)

	225	456
Input Voltage and Frequency	115 V (60 Hz); 230 V (50 Hz); 230 V (60 Hz)	
Voltage Tolerance	±10%	
Circuit Breakers	6 A (230 V models, quantity 2)	7 A (230 V models, quantity 2)
Current Draw	9.25 A (115 V, 60 Hz) 5.1 A (230 V, 50 Hz) 5.8 A (230 V, 60 Hz)	13.25 A (115 V, 60 Hz) 7.8 A (230 V, 50 Hz) 8.2 A (230 V, 60 Hz)
Power Source	Grounded outlet, meeting national electric code (NEC) and local electrical requirements	
Remote Alarm Capacity	iB, iPR models: 0.5 A at 30 V (RMS); 1.0 A at 24 V (DC) HB, HPR models: 0.25 A at 30 V (RMS); 0.25 A at 60 V (DC)	

CAUTIONS

- The interface on the remote alarm monitoring system is intended for connection to the end user's central alarm system(s) that uses normally-open or normally-closed dry contacts.
- If an external power supply exceeding 33 V (RMS) or 60 V (DC) is connected to the remote alarm monitoring system's circuit, the remote alarm will not function properly; may be damaged; or may result in injury to the user.

Table 6. Blood Bank Refrigerator Specifications

Model	Voltage Code	Amps	Cu. Ft/ Liters	Cabinet	Door	Drawers	Dimensions W x H x D in. (cm)	Net Wt. lbs (kg)
							Exterior	
iB225	115V 60 Hz	9.25	26.5 (750)	Upright	Single hinged glass	6	29.5 x 80 x 40 (750 x 2032 x 1016)	579 (263)
	230V 50 Hz	5.1						
	230 V 60 Hz	5.8						
HB225	115V 60 Hz	9.25	26.5 (750)	Upright	Single hinged glass	6	29.5 x 80 x 40 (750 x 2032 x 1016)	568 (258)
	230V 50 Hz	5.1						
	230 V 60 Hz	5.8						
iB456	115V 60 Hz	13.25	58 (1642)	Upright	Double hinged glass	12	59.25 x 80 x 40 (1499 x 2032 x 1016)	852 (387)
	230V 50 Hz	7.8						
	230 V 60 Hz	8.2						
HB456	115V 60 Hz	13.25	58 (1642)	Upright	Double hinged glass	12	59.25 x 80 x 40 (1499 x 2032 x 1016)	841 (382)
	230V 50 Hz	7.8						
	230 V 60 Hz	8.2						

Table 7. Pharmacy Refrigerator Specifications

Model	Voltage Code	Amps	Cu. Ft/ Liters	Cabinet	Door	Shelves/ Drawers	Dimensions W x H x D in. (cm)	Net Wt. lbs (kg)
							Exterior	
iPR225	115V 60 Hz	9.25	26.5 (750)	Upright	Single hinged glass	3/3	24.25 x 70.5 x 28.25 (616 x 1791 x 718)	534 (243)
	230V 50 Hz	5.1						
	230 V 60 Hz	5.8						
HPR225	115V 60 Hz	9.25	26.5 (750)	Upright	Single hinged glass	3/3	24.25 x 70.5 x 28.25 (616 x 1791 x 718)	523 (238)
	230V 50 Hz	5.1						
	230 V 60 Hz	5.8						
iPR456	115V 60 Hz	13.25	58 (1642)	Upright	Double hinged glass	6/6	59.25 x 80 x 40 (1499 x 2032 x 1016)	797 (362)
	230V 50 Hz	7.8						
	230 V 60 Hz	8.2						
HPR456	115V 60 Hz	13.25	58 (1642)	Upright	Double hinged glass	6/6	59.25 x 80 x 40 (1499 x 2032 x 1016)	786 (357)
	230V 50 Hz	7.8						
	230 V 60 Hz	8.2						

i Notes

Maximum load per shelf or drawer - 100 lbs (46kg)

6 Compliance

6.1 Regulatory Compliance

This product is certified to applicable UL and CSA standards by a NRTL

This device complies with the requirements of directive 93/42/EEC concerning Medical Devices, as amended by 2007/47/EC.



Sound level is less than 70 dB(A).



Emergo Europe
Molenstraat 15
2513 BH
The Hague, Netherlands



6.2 WEEE Compliance

The WEEE (waste electrical and electronic equipment) symbol (right) indicates compliance with European Union Directive WEEE 2002/96/EC and applicable provisions. The directive sets requirements for the labeling and disposal of certain products in affected countries.

When disposing of this product in countries affected by this directive:

- ◆ Do not dispose of this product as unsorted municipal waste.
- ◆ Collect this product separately.
- ◆ Use the collection and return systems available locally.

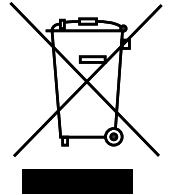

For more information on the return, recovery, or recycling of this product, contact your local distributor.

7 Preventive Maintenance

Notes

- It is important to ensure that all scientific equipment is maintained regularly for optimum performance.
- These are recommended minimum requirements. Regulations for your organization or physical conditions at your facility may require maintenance items to be performed more frequently, or only be designated service personnel.

Maintenance tasks should be completed according to the following schedule. Refer to the service manual and the i.C³ User Guide for detailed information on tasks.

Table 8. Preventive Maintenance Schedule

Task	Frequency		
	Quarterly	Annually	As Needed
Test the high and low temperature alarms.	✓		
Test the power failure alarm (as required by your organization's protocols).	✓		
Test the door alarm (as required by your organization's protocols).			✓
Check the temperature calibration on the monitor and change it if necessary.	✓		
Models with chart recorders Check the backup battery for the chart recorder after an extended power failure and change it if necessary, or change the battery if it has been in service for one year. Refer to the Temperature Chart Recorder Operation and Service Manual.			✓
<ul style="list-style-type: none"> • Inspect electrical components and wiring terminals in the electrical box for discoloration. Contact Helmer Technical Service if any discoloration is found. • Inspect all wiring terminals for secure connection. Tighten wiring terminal connections as necessary. 	✓		
Check the level of the solution in the probe bottle(s). Refill or replace solution if necessary.			✓
Examine the probe bottle(s) and clean or replace if necessary.		✓	
Clean the condenser grill.	✓		
Clean the door gaskets, interior, and exterior of the refrigerator.			✓
Inspect ground strap. <small>Units prior to serial number 2022299</small>	✓ (i.Series)		

NOTICE

Clean the condenser grill on a quarterly basis.

Notes

- During a power failure, the back-up battery provides power to the monitoring system and the power failure alarm. If the back-up battery is not functioning, the power failure alarm will not be activated.
- If the back-up battery does not provide power to the monitoring system during the power failure alarm test, replace the battery.
- i.Series: If rechargeable battery has been in service for two years, replace battery.
- Horizon Series: If monitoring system battery has been in service for one year, replace battery.

Appendix A

i.Series Parts

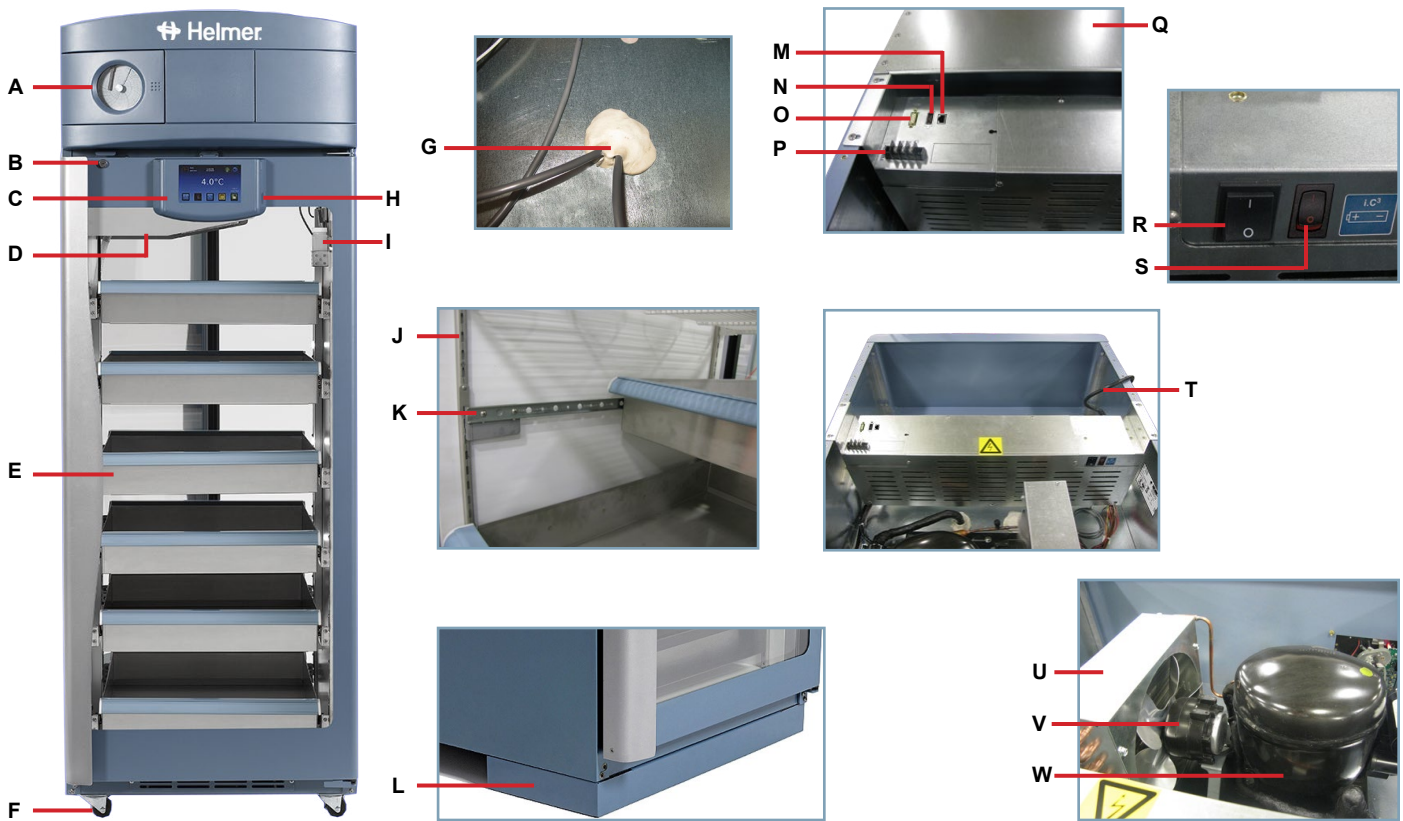

Table 9. i.Series Parts and Description

Letter	Description	Letter	Description
A	Chart recorder (standard on blood bank models / optional on pharmacy models)	M	USB port
B	Door lock	N	RJ-45 Ethernet port
C	i.C ³ control	O	RS-232 COM port (optional)
D	Unit cooler with fan guard	P	Remote alarm interface
E	Drawer (two-way)	Q	Cover (clean room side)
F	Caster	R	Main power switch
G	Access Port (number and location vary by model)	S	Back-up battery switch
H	USB	T	Power cord
I	Primary probe bottle	U	Condenser
J	Standard for adjusting storage components	V	Condenser fan motor
K	Drawer/basket slide	W	Compressor
L	Skirt (optional, installed on the clean room, or non-control side)	Not shown	Monitoring system back-up battery
Not shown	Secondary probe bottle		

Appendix B Horizon Series Parts

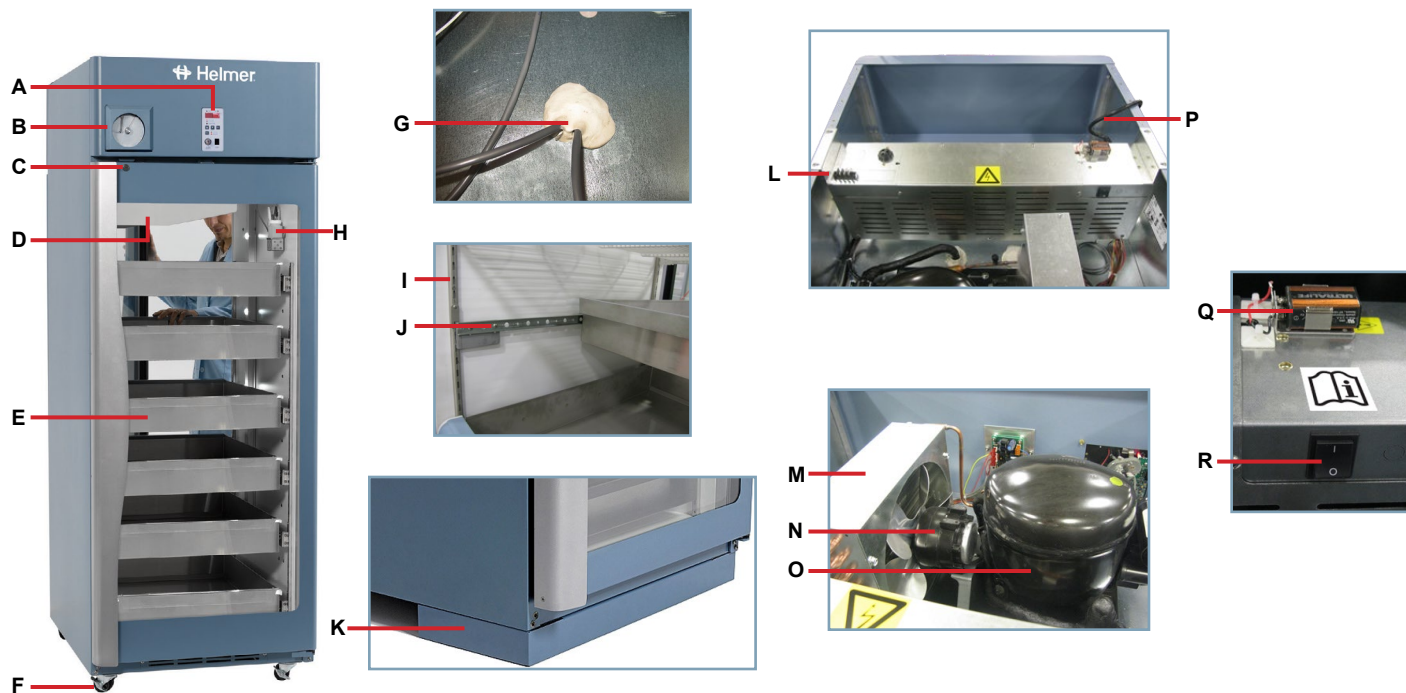

Table 10. Horizon Series Parts and Description

Letter	Description	Letter	Description
A	Horizon temperature monitor and control	K	Skirt (optional, installed on the clean room, or non-control side)
B	Chart recorder (standard on blood bank models / optional on pharmacy models)	L	Remote alarm interface
C	Door lock	M	Condenser
D	Unit cooler with fan guard	N	Condenser fan and motor
E	Drawer (two-way)	O	Compressor
F	Caster	P	Power cord
G	Access Port (number and location vary by model)	Q	Monitoring system back-up battery
H	Primary probe bottle	R	Main power switch
I	Standard for adjusting storage components	Not shown	Cover (clean room side)
J	Drawer/basket slide		

END OF MANUAL

